

ENERGY MANAGEMENT SOLUTIONS

PULSAR PLUS, PULSAR PLUS SOCKET, PULSAR MAX, PULSAR PRO,
COMMANDER 2/2S, COPPER SB

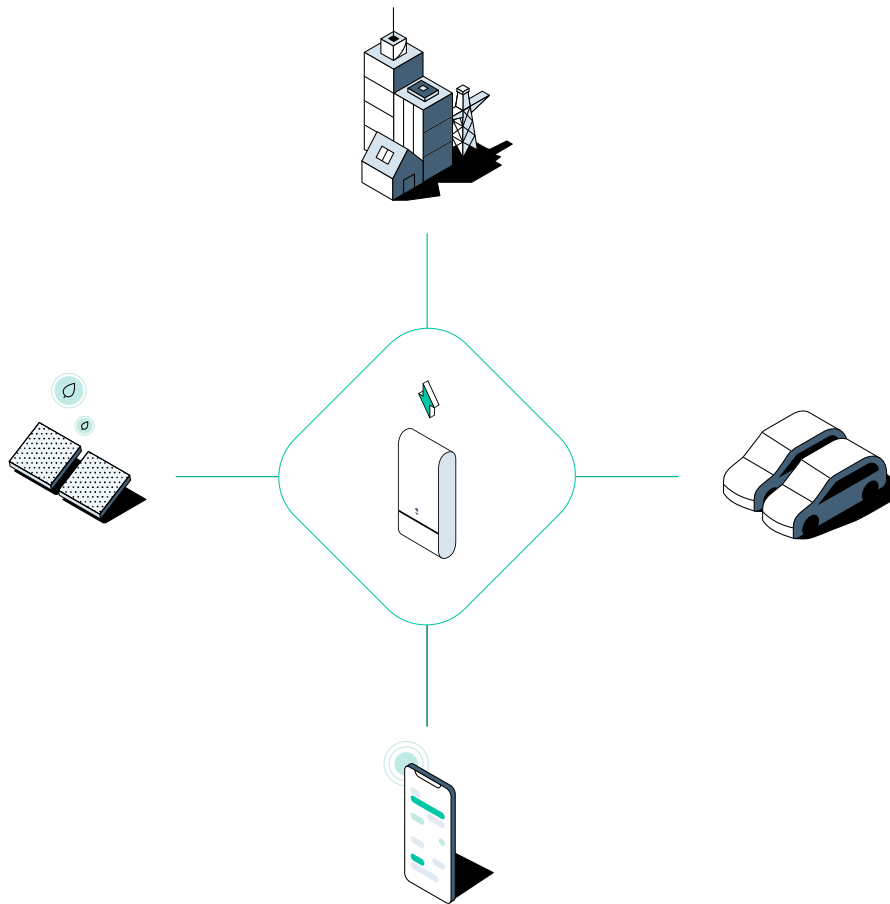

INSTALLATION GUIDE

Europe

AC Chargers | July, 2024

wallbox 

Index

PURPOSE AND SCOPE OF THE DOCUMENT	4
BEFORE STARTING	5
EMS INSTALLATION	6
Meters Compatibility Table	6
Pulsar Plus/Pulsar Plus Socket Socket	7
Dynamic Load Management and Solar Charging	7
Static Load Management	13
Dynamic Load Management (2+ Chargers)	19
Commander 2/2S	28
Dynamic Load Management and Solar Charging	28
Static Load Management	34
Dynamic Load Management (2+ Chargers)	41
Copper SB	49
Dynamic Load Management and Solar Charging	49
Static Load Management	55
Dynamic Load Management (2+ Chargers)	61
Pulsar Max/Pulsar Pro	70
Meters Compatibility Table	70
Dynamic Load Management and Solar Charging	71
Static Load Management	77
Dynamic Load Management (2+ Chargers)	83
EMS CONFIGURATION AND TROUBLESHOOTING	91
Dynamic Load Management	92
Solar Charging	95
Static Load Management	98
Dynamic Load Management (2+ Chargers)	99
Troubleshooting	101
METERS CONFIGURATION GUIDE	102
EM330 Configuration (Only for 400 A and 600 A clamps)	103
How to install N1 CT	104
How to install P1 Port	105

Purpose and Scope of the Document

The purpose of this document is to outline the instructions for the installation and configuration of the Wallbox Energy Management Solutions.

To install an MID meter, refer to the MID meters [Installation Guide](#).

Before Starting

This guide is organized by charger type and offers comprehensive instructions for installing and wiring your charger, along with the energy meter when necessary, for each Energy Management Solution (EMS). At the end of the guide, you will find a section dedicated to configuring the energy meter of your choice, in case the instructions provided with the energy meter are insufficient, as well as a Troubleshooting section.

Before beginning your installation, **please read this section carefully to ensure you have all the necessary knowledge to understand and implement the procedures outlined in this document.**

Definitions

Dynamic Load Management (DLM)

Dynamic Load Management is a feature that optimizes the distribution of electrical load among multiple devices to prevent overload and ensure efficient energy usage. DLM can be implemented in two ways:

- **Single Charger Setup:** Requires an energy meter and balances the load between a single charger and the house appliances, called “Dynamic Load Management” in this document.

- **Multiple Chargers Setup (2+ Chargers):** Requires an energy meter and manages the load among multiple chargers and the house appliances. Note that we refer to it as “Dynamic Load Management (2+ Chargers)” in this document.

Solar Charging

This system is designed to harness renewable energy, reducing dependence on the grid. However, it is important to note that **Solar Charging is not compatible with Static Load Management or Dynamic Load Management (2+ Chargers)** and thus cannot operate simultaneously with these systems.

Before Starting

Static Load Management (SLM)

Static Load Management refers to a system where the electrical load is managed in a predefined and fixed manner. Unlike DLM, SLM does not adjust dynamically to the fluctuating power demands of the house appliances and chargers.

Important

- A.** **This document is only reserved to qualified installers.** It must always be followed in accordance with applicable local regulations.
- B.** Only energy meters provided by Wallbox are compatible with Wallbox chargers.
- C.** Install the charger following the instructions listed in the chargers’ [Installation Guide](#). And ensure you choose the right energy meter, following the corresponding [Compatibility Table \(page 6 and 69\)](#).
- D.** Update the Wallbox charger with the latest software version before installing the energy meter. Refer to the instructions for updating the charger on the [Wallbox Support Website](#) page for more information.
- E.** Ensure that the charger is powered off and its cover is removed before connecting the energy meter. Close the charger properly after the installation.
- F.** After installing the charger, connect the energy meter before closing your charger. In case the energy meter is to be connected to a previously installed charger, open it to connect the energy meter.

Inside the Package

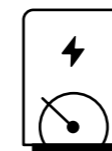

Energy Meter



Grommet

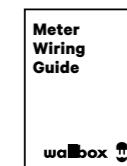

Meter Wiring Guide

INSTALLATION

Getting started

General Characteristics

(Pulsar Plus, Pulsar Plus Socket, Commander 2/2S, Copper SB)

	Dynamic Load Management (1 Charger)	Solar Charging	Static Load Management	Dynamic Load Management (2+ chargers)
Primary Chargers	1	1	1	1
Secondary Chargers	-	-	1-24	1-24
Communication protocol between chargers	-	-	CAN	CAN
Communication protocol between the Primary Charger and the Energy Meter	Modbus RTU	Modbus RTU	-	Modbus RTU
Maximum total length of wiring CAN network	-	-	250m	250m
Maximum length between the wiring of the Primary charger and the Energy Meter	500m	500m	-	500m
Terminating Chargers	1	1	2	2
Maximum Phase Current configurable	Minimum between main switch rated (MCB) and the contract tariff	-	-	Minimum between main switch rated (MCB) and the contract tariff
Configurable Installation maximum current	-	-	Installation main switch rated current (MCB)	Installation main switch rated current (MCB)
Wallbox App	Super admin or admin account	Super admin or admin account	Super admin or admin account	Super admin or admin account

Meters Compatibility Table

Meters	Dynamic Load Management (1 Charger)	Solar Charging	Dynamic Load Management (2+ Chargers)
EM340	✓	✓	✓
EM112	✓	✓	✓
SPM1-100-AC	✓	✗	✓
EM330 CTA 5X 250 A 5A	✓	✓	✓
EM330 CTA 6X 400 A 5A	✓	✓	✓
EM330 CTA 6X 600A 5A	✓	✓	✓
N1CT	✓	✓	✓
PRO2 MOD	✓	✓	✓
PRO380 MOD	✓	✓	✓

INSTALLATION WITH PULSAR PLUS/PULSAR PLUS SOCKET

Dynamic Load Management and Solar Charging

Tools

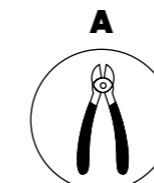

Cutting Pliers

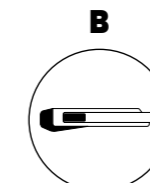

Utility Knife

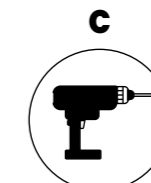

Drilling machine M12 and hole saw 25mm

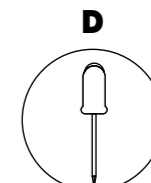

Flat Screwdriver 6mm

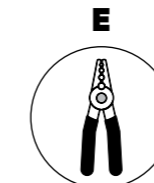

Wire Strippers

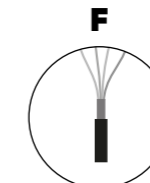

Connecting cable between charger and meter (STP Class 5E 500m Max Length)

Refer to the **Pulsar Plus/Pulsar Plus Socket Installation Guide** to know more about the tools to install the charger.



Solar Charging cannot be used simultaneously with Static Load Management and Dynamic Load Management (2+ Chargers). However, it is fully compatible with Dynamic Load Management.

INSTALLATION WITH PULSAR PLUS/PULSAR PLUS SOCKET

Dynamic Load Management and Solar Charging

Place the energy meter after the mains supply and before the fuse box.

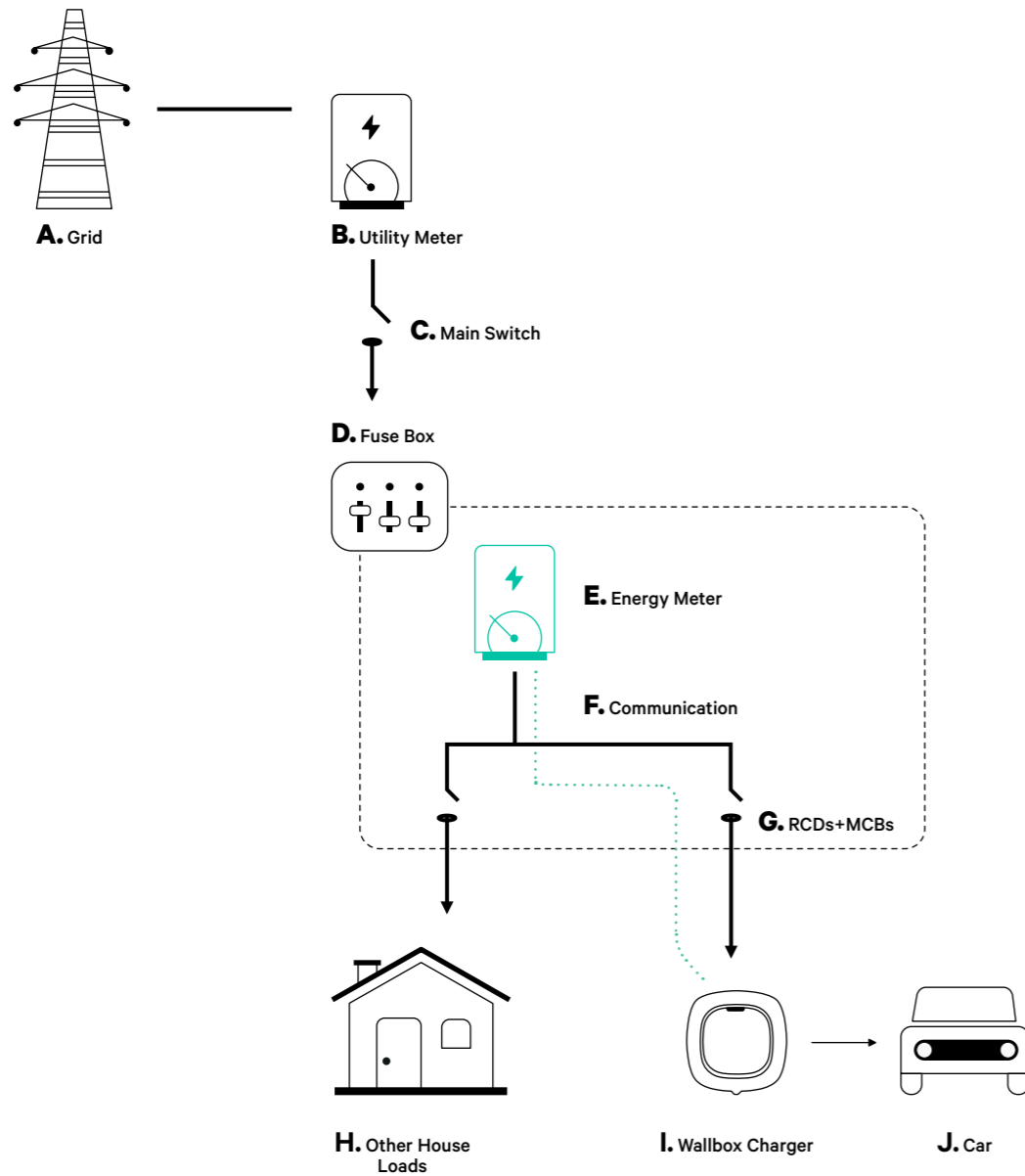

INSTALLATION WITH PULSAR PLUS/PULSAR PLUS SOCKET

Dynamic Load Management and Solar Charging

Before Installation

- Ensure that the power is turned off during the installation.
- Separate the communication wires from the power ones.

Preparation

1. Make a hole at the bottom of the charger using a M12 drill.

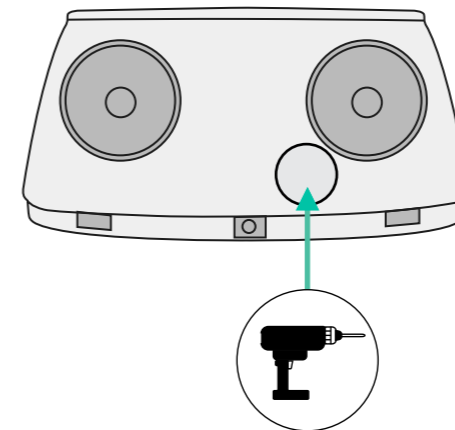

2. With a flat screwdriver, make an incision in the grommet included in the meters package.

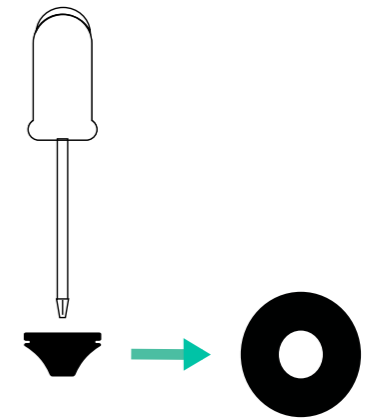

3. Insert the **grommet** in the bottom hole of the charger.

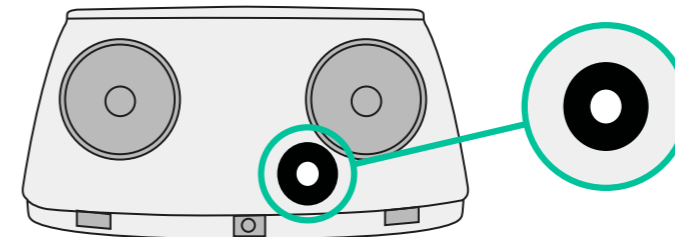

INSTALLATION WITH PULSAR PLUS/PULSAR PLUS SOCKET

Dynamic Load Management and Solar Charging

Pulsar Plus/Pulsar Plus Socket Installation Guide

Install the charger following the instructions in the [Pulsar Plus/Pulsar Plus Socket Installation Guide](#).



Important

Ensure not to close the cover of the charger.

Communication wiring between the charger and the meter

1. Keep the power turned off during the installation.
2. Insert the communication wire through the grommet.

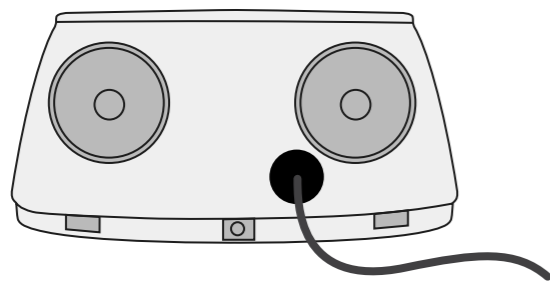

3. Install the meter following the instructions in the Meter Wiring Guide included in the package.
4. Wire the meter and the charger by following the relevant scheme below based on the model of your meter.



Important

It is mandatory to use an STP class 5E cable. Employ only 1 wire of each twisted pair and keep in mind that the communication wiring must not be more than 500m long.



Important

Insert only one cable for each grommet.

INSTALLATION WITH PULSAR PLUS/PULSAR PLUS SOCKET

Dynamic Load Management and Solar Charging

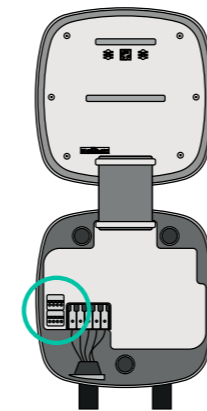

EM 112

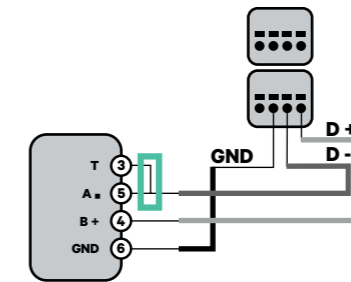

EM 340

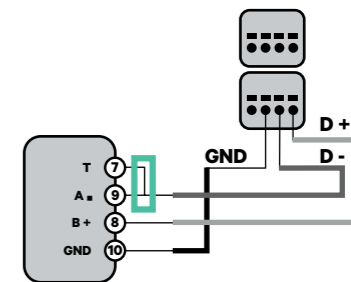

EM 330

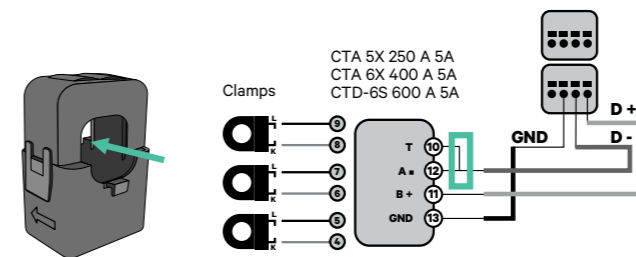

! For the EM330 configuration refer to the [Meter Configuration Guide section](#).

N1 CT

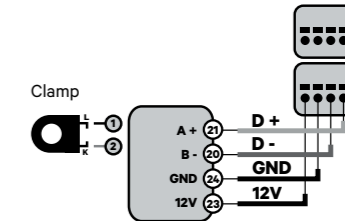

! For the N1CT installation, refer to the [Meter Configuration Guide section](#).

P1 Port

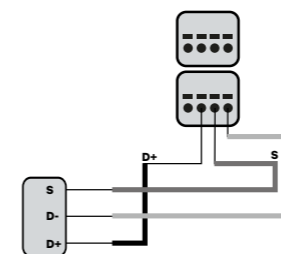

! For the P1 Port installation, refer to the [Meter Configuration Guide section](#).

SPM1-100-AC

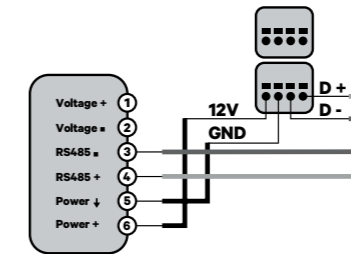

Pro MOD2

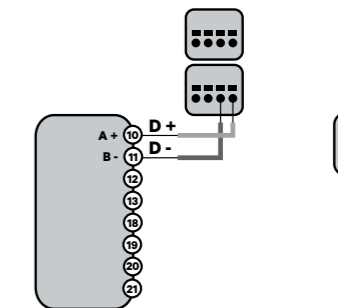

Pro 380 MOD

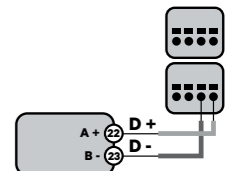

Important

Remember to check the [Meter Compatibility Table](#).

INSTALLATION WITH PULSAR PLUS/PULSAR PLUS SOCKET

Dynamic Load Management and Solar Charging

Terminating resistance activation and current selector configuration

- Put the RS485 switch into position T.
- Put the rotary switch into a position between 1 and 7, depending on the maximum current that can be supplied from the charging network.

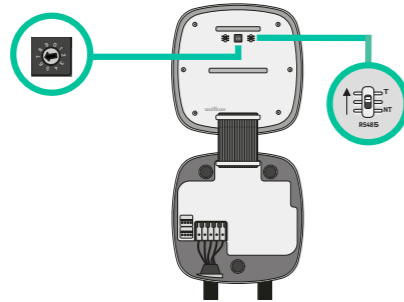

- See the matrix below. This value must be equal or lower than the MCB protecting the Wallbox power line.

POSITION	0	1	2	3	4	5	6	7	8	9
CURRENT (A)	R	6	10	13	16	20	25	32	R	R

Note: Only Max Current > 6A per phase is accepted for a correct performance. In case of doubt, contact Wallbox Service.

- Close the cover of the charger following the instructions in the charger's **Installation Guide**.

INSTALLATION WITH PULSAR PLUS/PULSAR PLUS SOCKET

Static Load Management

Tools

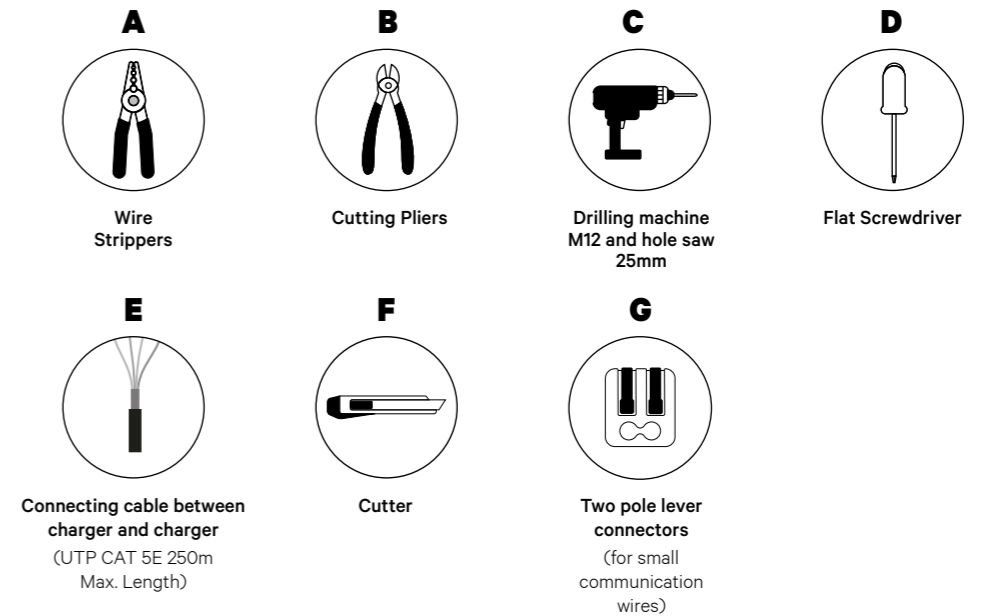

Refer to the **Pulsar Plus/Pulsar Plus Socket Installation Guide** to know more about the tools to install the charger.



Important

Please note that **Static Load Management cannot be used simultaneously with Solar Charging**. Ensure you choose the most suitable power management option for your needs.

INSTALLATION WITH PULSAR PLUS/PULSAR PLUS SOCKET Static Load Management

Before Installation

- Ensure that the power is turned off during the installation.
- Separate the communication wires from the power ones.

Preparation

1. Make a hole at the bottom of the charger using a M12 drill.

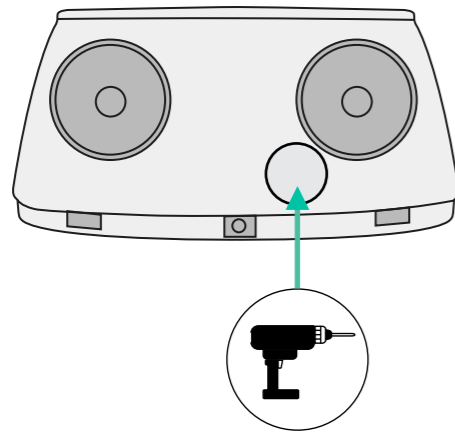

2. With a flat screwdriver, make an incision in the grommet included in the meter's package.

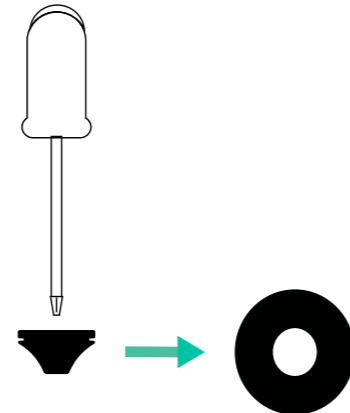

3. Insert the **grommet** in the bottom hole of the charger.

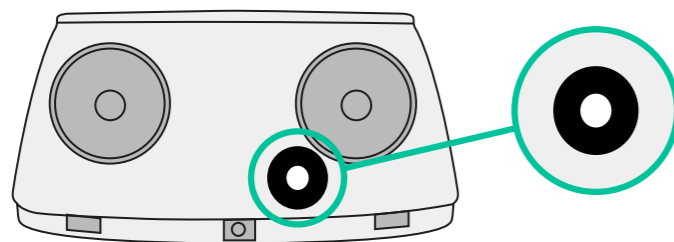

Pulsar Plus/Pulsar Plus Socket Installation

Install the charger following the instructions in the [Pulsar Plus/Pulsar Plus Socket Installation Guide](#).



Important

Ensure not to close the cover of the charger.

INSTALLATION WITH PULSAR PLUS/PULSAR PLUS SOCKET Static Load Management

Wiring the system

1. Ensure that the power is turned off during the installation.
2. Insert the communication wire (UTP 5E cable) through the grommet.

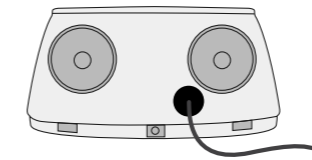

3. Check the position of CAN - L and CAN - H indicated above the connector. **Remember:** the sequence in the connector can be different depending on each product.

4. Once located the connector, start cabling the primary charger (the first of the chain). Use a UTP 5E cable (a pair), then, insert one of the cables in CAN-L and the other in CAN-H. After, connect the other chargers of the chain following the scheme below. As you may notice, all the chargers have CAN-L and a CAN-H inputs and outputs, except for the first and the last ones.

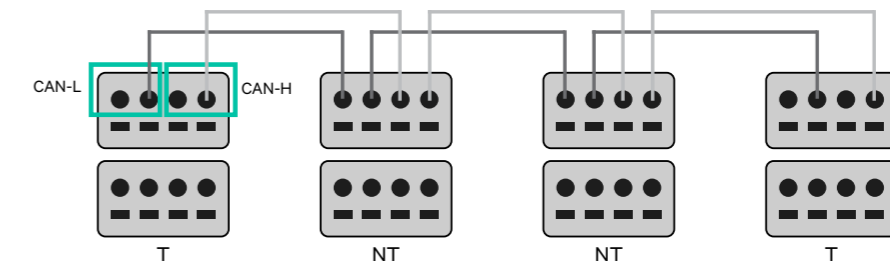

INSTALLATION WITH PULSAR PLUS/PULSAR PLUS SOCKET Static Load Management



Important

- Make sure to connect each CAN-L to the respective CAN-L connector of all the chargers. Do the same for CAN-H.
- Static Load Management works up to 25 chargers for each installation. Among them, one is primary and 24 are secondary. The maximum distance the communication wiring can reach is 250m.

	CAN-L	CAN-H
CAN-L	✓	✗
CAN-H	✗	✓

Note: Only Max Current > 6A per phase is accepted for a correct performance. In case of doubts, contact Wallbox Service.

Refer to the **Installation Guide** for more information.

Terminating settings

1. Once the cabling is completed, you need to activate the termination resistors. The first and the last charger will always be terminating (T) with non terminating (NT) chargers between them.

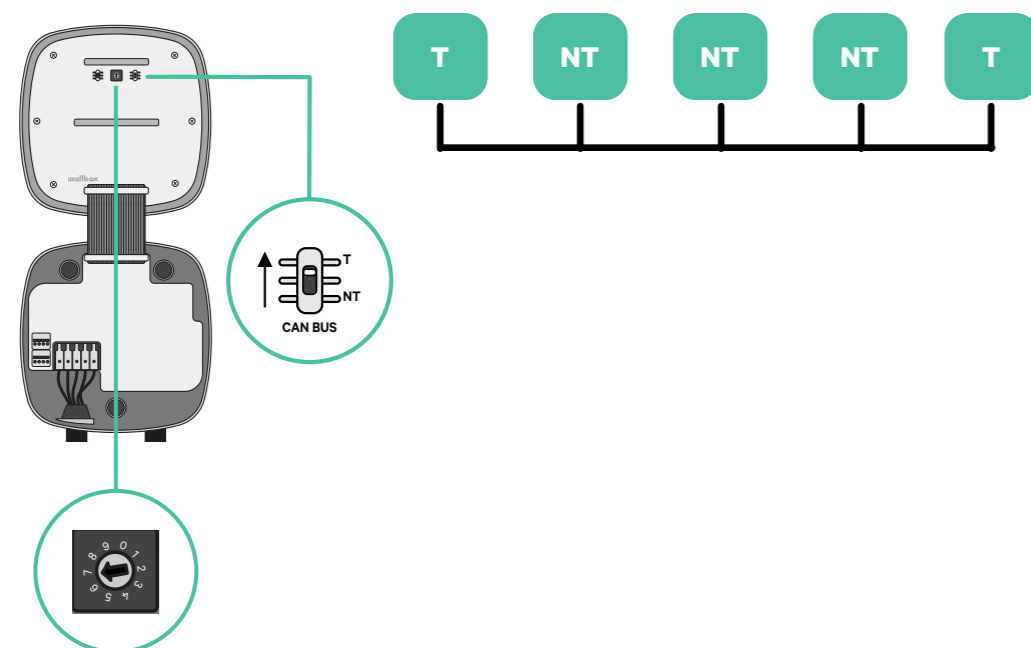

INSTALLATION WITH PULSAR PLUS/PULSAR PLUS SOCKET Static Load Management

2. Once the termination resistors are set up, place the current selector of each charger following the information. The first charger of the chain is the primary charger, the others are secondary.

The **primary charger** will be set on position 8 or 9.

The **secondary chargers** will be set on position 0.

POSITION	0	1	2	3	4	5	6	7	8	9
MAX CURRENT	*PS	6	10	13	16	20	25	32	*PS	*PS

3. To ensure a proper set-up the measured **resistance between CAN-H and CAN-L must be near to 60 Ohms**. If it differs from that, recheck the proper wiring and the T/NT configuration.

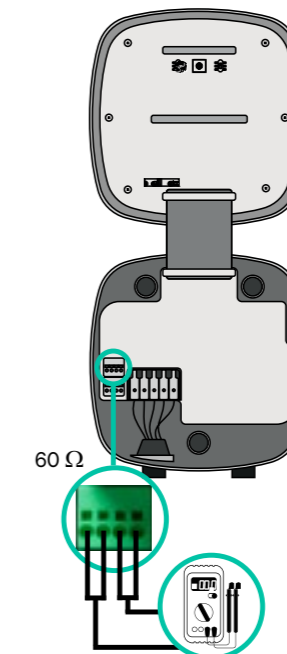

4. Close the cover of your charger by following the instructions in the respective **Installation Guide**.

INSTALLATION WITH PULSAR PLUS/PULSAR PLUS SOCKET Static Load Management

Adding chargers in the future:

If you anticipate adding chargers in the future, there are two ways you can prepare the infrastructure to make it ready for Static Load Management.

Option 1: Place a bus disconnecter to accommodate future chargers as shown in the option 1 wiring scheme below. This option avoids the need of reopening the existing chargers and hence it is the recommended option.

Option 2: Truncate the existing bus to add new charger(s) as shown in the option 2 wiring scheme below.

1. Open the charger following the installation guide of your Pulsar Plus/Pulsar Plus Socket charger.
2. Set the terminating resistance into NT, make the communication wiring as explained above and then close the charger.

Option 1:

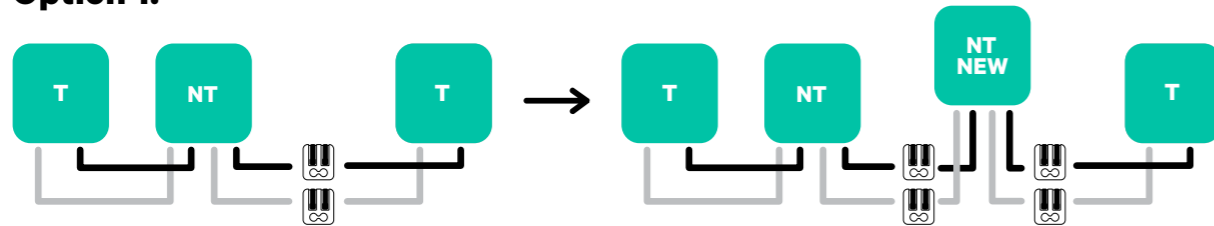

Option 2:

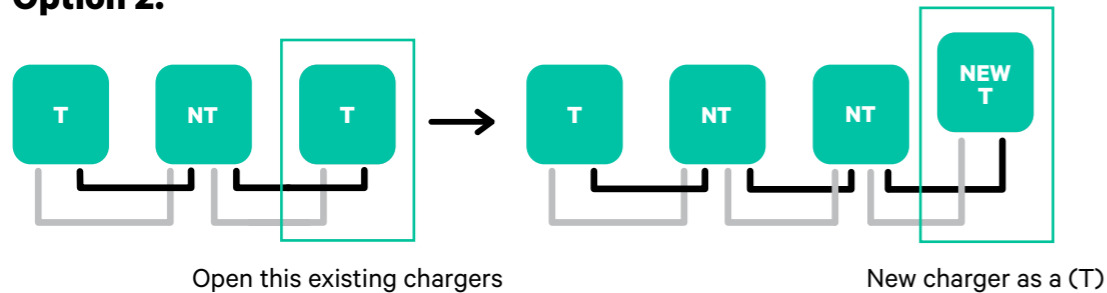

Important

New chargers may be placed anywhere physically in relation to the existing chargers as long as you follow these rules:

- You maintain the logic of the daisy chain.
- You respect the cabling polarity as described above under “Installation”.

Wherever a future added charger is placed, the most important rule to follow is the logic of the daisy chain. For example, in the image below, the new charger is placed before the Terminating charger on the right side of the daisy chain.

INSTALLATION WITH PULSAR PLUS/PULSAR PLUS SOCKET Dynamic Load Management (2+ Chargers)

Tools

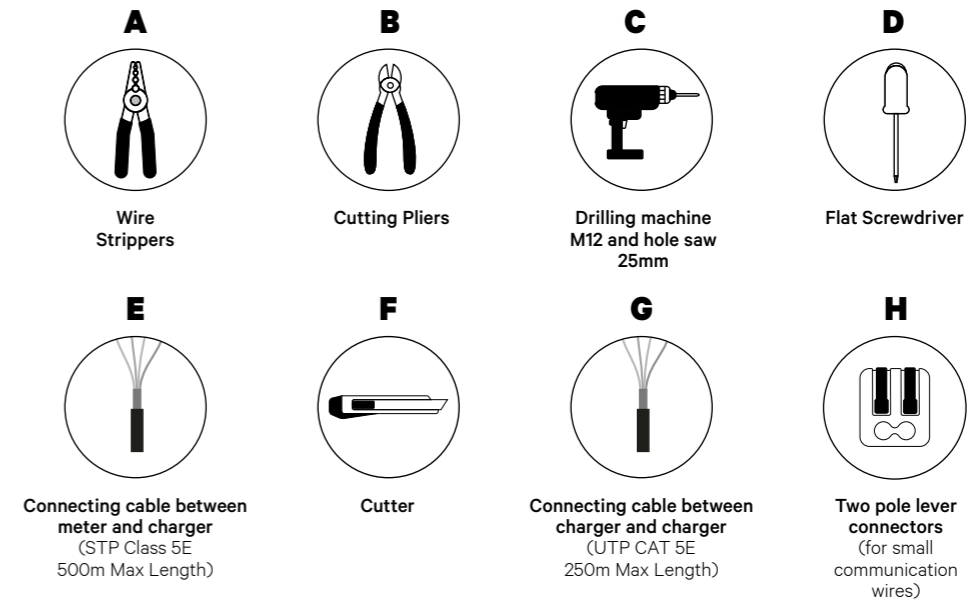

Refer to the **Pulsar Plus/Pulsar Plus Socket Installation Guide** to know more about the tools to install the charger.



Important

Please note that **Dynamic Load Management (2+ Chargers) cannot be used simultaneously with Solar Charging**. Ensure you choose the most suitable power management option for your needs.

INSTALLATION WITH PULSAR PLUS/PULSAR PLUS SOCKET

Dynamic Load Management (2+ Chargers)

Before Installation

- Ensure that the power is turned off during the installation.
- Separate the communication wires from the power ones.

Preparation

1. Make a hole at the bottom of the charger using a M12 drill.

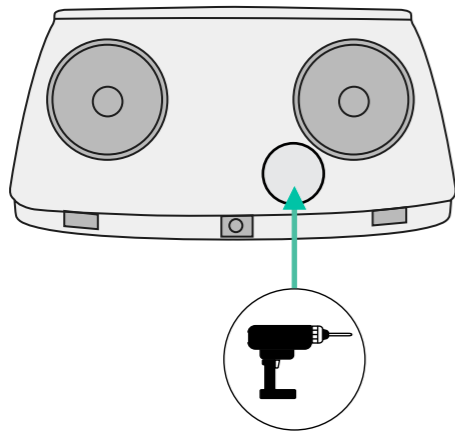

2. With a flat screwdriver, make an incision in the grommet included in the meters package.

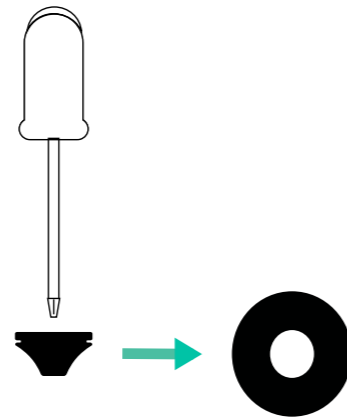

3. Insert the grommet in the bottom hole of the charger.

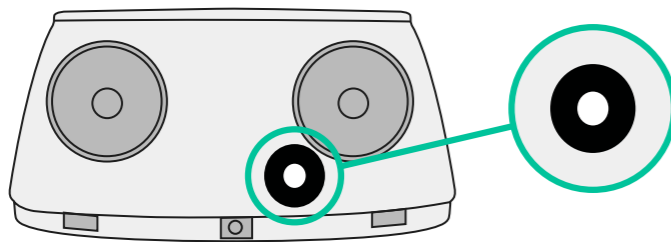

INSTALLATION WITH PULSAR PLUS/PULSAR PLUS SOCKET

Dynamic Load Management (2+ Chargers)

Pulsar Plus/Pulsar Plus Socket Installation Guide

Install the charger following the instructions in the [Pulsar Plus/Pulsar Plus Socket Installation Guide](#).



Important

Ensure not to close the cover of the charger.

Communication wiring between the charger and the meter

1. Keep the power turned off during the installation.
2. Insert through the grommet the two communication wires, one for meter communication and the other one for communication between chargers.

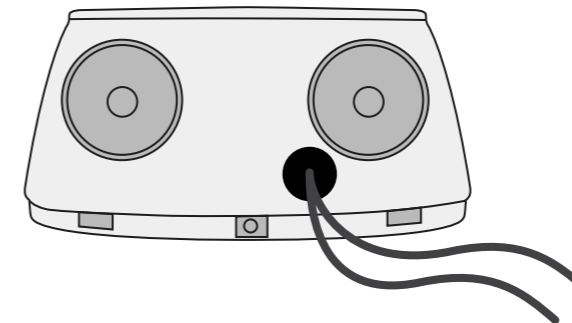

3. Install the meter following the instructions in the Meter Wiring Guide included in the package.
4. Wire the meter and the charger by following the relevant scheme below based on the model of your meter.



Important

It is mandatory to use an STP class 5E cable. Employ only 1 wire of each twisted pair and keep in mind that the communication wiring must not be more than 500m long.

INSTALLATION WITH PULSAR PLUS/PULSAR PLUS SOCKET

Dynamic Load Management (2+ Chargers)

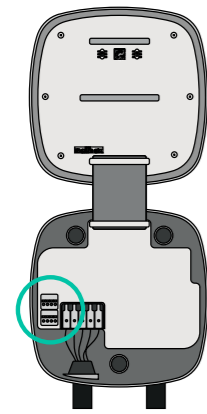

EM 112

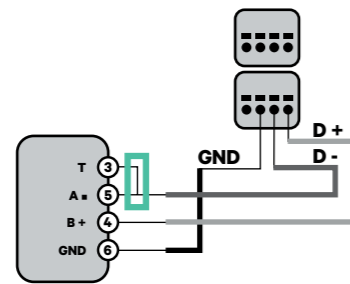

EM 340

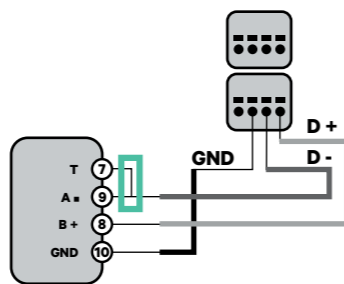

EM 330

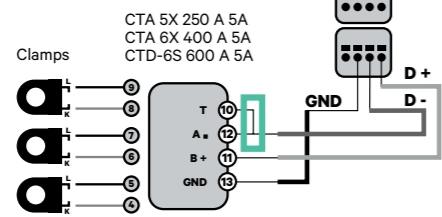

! For the EM330 configuration refer to the **Meter Configuration Guide section**.

N1 CT

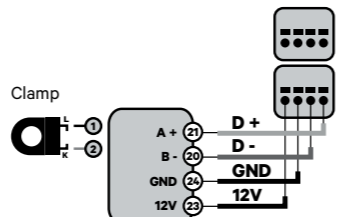

! For the N1CT installation, refer to the **Meter Configuration Guide section**.

P1 Port

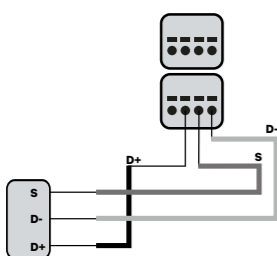

! For the P1 Port installation, refer to the **Meter Configuration Guide section**.

SPM1-100-AC

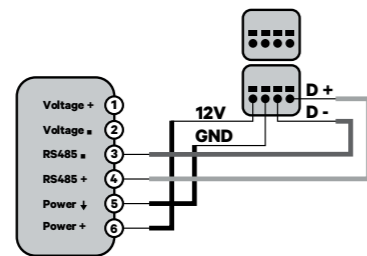

Pro MOD2

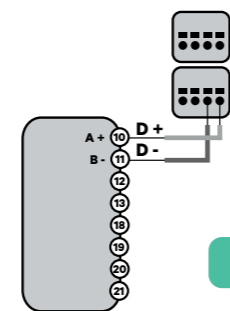

Pro 380 MOD

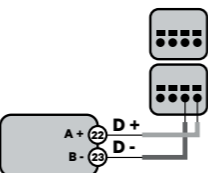

Important
Remember to check the **Meter Compatibility Table**.

INSTALLATION WITH PULSAR PLUS/PULSAR PLUS SOCKET

Dynamic Load Management (2+ Chargers)

Wiring the system

1. Ensure that the power is turned off during the installation.
2. Check the position of CAN - L and CAN - H indicated above the connector.
Remember: the sequence in the connector can be different depending on each product.
3. Once located the connector, start cabling the primary charger (the first of the chain). Use a UTP 5E cable (a pair), then, insert one of the cables in CAN-L and the other in CAN-H. After, connect the other chargers of the chain following the scheme below. As you may notice, all the chargers have CAN-L and a CAN-H inputs and outputs, except for the first and the last ones.

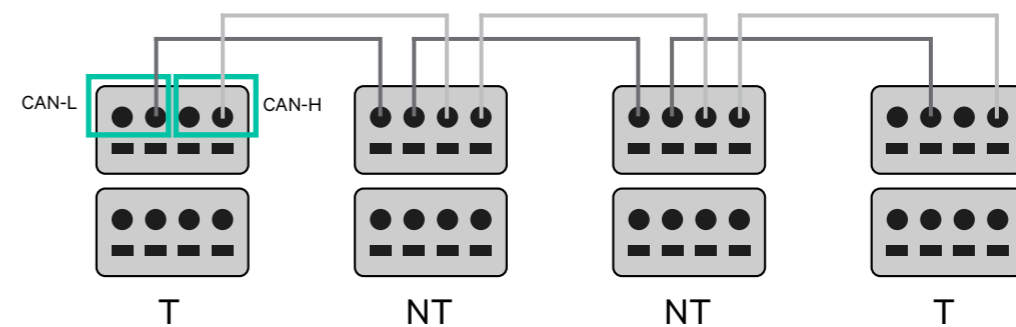

Important

- Make sure to connect each CAN-L to the respective CAN-L connector of all the chargers. Do the same for CAN-H.
- Static Load Management works up to 25 chargers for each installation. Among them, one is primary and 24 are secondary. The maximum distance the communication wiring can reach is 250m.

INSTALLATION WITH PULSAR PLUS/PULSAR PLUS SOCKET

Dynamic Load Management (2+ Chargers)

	CAN-L	CAN-H
CAN-L	✓	✗
CAN-H	✗	✓

Note: Only Max Current > 6A per phase is accepted for a correct performance. In case of doubts, contact Wallbox Service.

Terminating settings

- Once the cabling is complete, you need to activate the terminating resistors. First set up RS485 into T only for the charger that is connected into meter. Then set up the CAN BUS, the first and the last charger will always be terminating (T) with non terminating (NT) chargers between them.

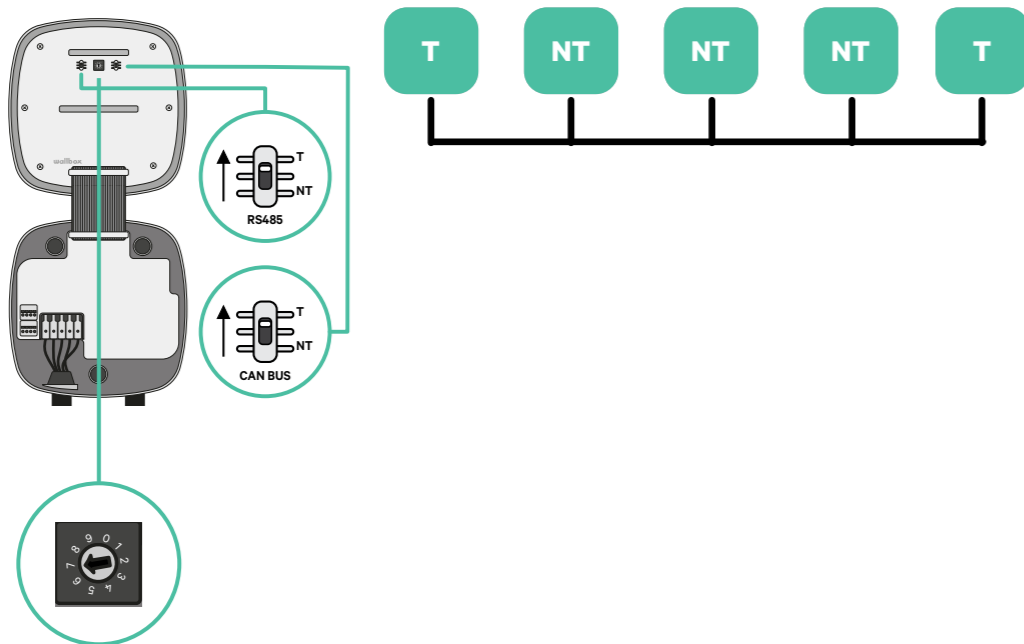

INSTALLATION WITH PULSAR PLUS/PULSAR PLUS SOCKET

Dynamic Load Management (2+ Chargers)

- Once the termination resistors are set up, place the current selector of each charger following the information. The first charger of the chain is the primary charger, the others are secondary.

The **primary charger** will be set on position 8 or 9.

The **secondary chargers** will be set on position 0.

POSITION	0	1	2	3	4	5	6	7	8	9
MAX CURRENT	*PS	6	10	13	16	20	25	32	*PS	*PS

- To ensure a proper set-up the measured **resistance between CAN-H and CAN-L must be near to 60 Ohms**. If it differs from that, recheck the proper wiring and the T/NT configuration.

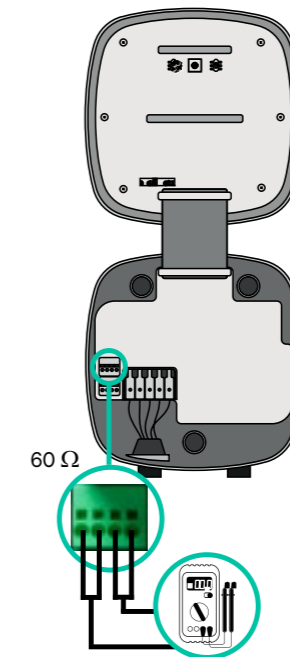

- Close the cover of your charger by following the instructions in the respective **Installation Guide**.

INSTALLATION WITH PULSAR PLUS/PULSAR PLUS SOCKET Dynamic Load Management (2+ Chargers)

Example of an installation with four chargers (CAN-bus)

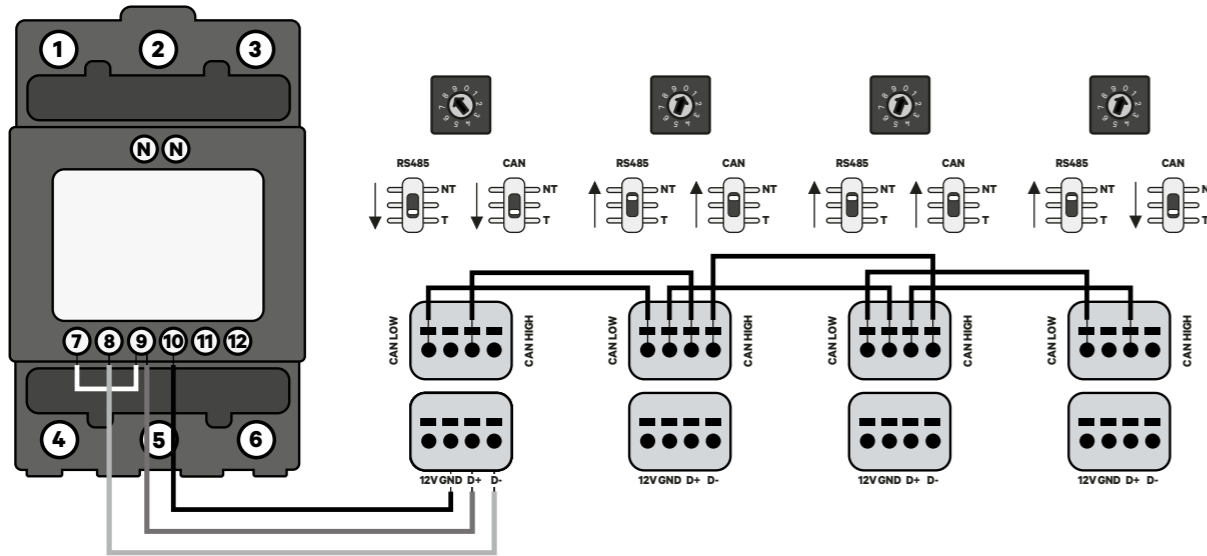

Adding chargers in the future:

If you anticipate adding chargers to the system in the future, there are two ways you can prepare the system now to make it ready for Dynamic Load Management (2+ Chargers).

Option 1: Place a bus disconnector to accommodate future chargers as shown in the option 1 wiring scheme below. This option avoids the need of reopening the existing chargers and hence it is the recommended option.

Option 2: Truncate the existing bus to add new charger(s) as shown in the option 2 wiring scheme below.

1. Open the charger following the installation guide of your Pulsar Plus/Pulsar Plus Socket charger.
2. Set the terminating resistance into NT, make the communication wiring as explained above and then close the charger.



Important

New chargers may be placed anywhere physically in relation to the existing chargers as long as you follow these rules:

- You maintain the logic of the daisy chain.
- You respect the cabling polarity as described above under “Installation”.

INSTALLATION WITH PULSAR PLUS/PULSAR PLUS SOCKET Dynamic Load Management (2+ Chargers)

Wherever a future added charger is placed, the most important rule to follow is the logic of the daisy chain. For example, in the image below, the new charger is placed before the Terminating charger on the right side of the daisy chain.

Option 1:

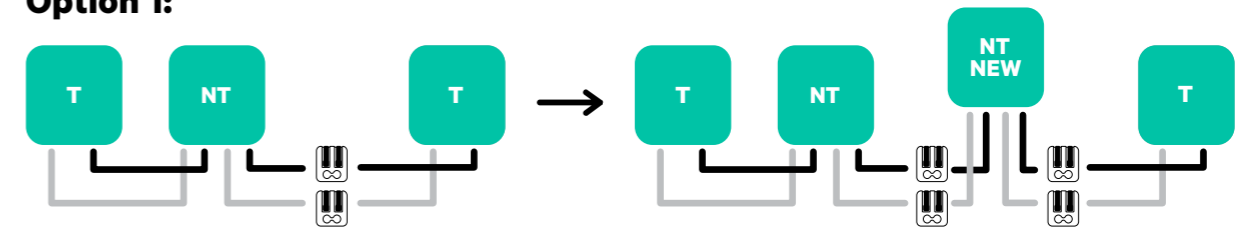

Option 2:

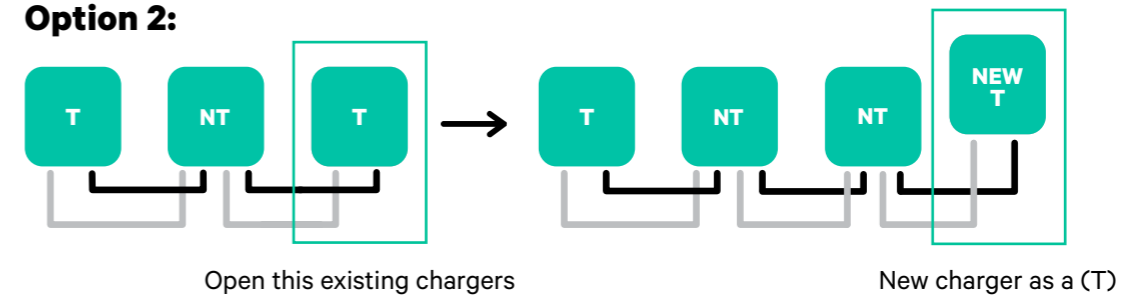

Once you finish the extension of the existing installation, continue with steps on the next page for setting up the chargers.

Dynamic Load Management and Solar Charging

Tools

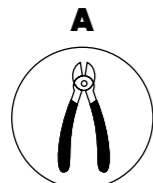

A. Cutting Pliers

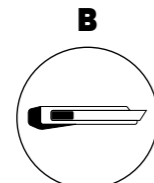

B. Utility Knife

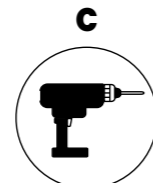

C. Drilling machine
M12 and hole saw
25mm

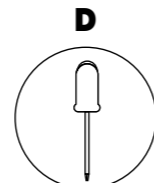

D. Flat Screwdriver
6mm

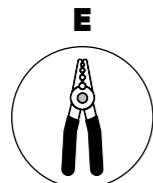

E. Wire Strippers

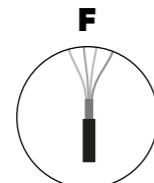

F. Connecting cable between
charger and meter
(STP Class 5E
500m Max Length)

Refer to the **Commander 2/2S Installation Guide** to know more about the tools to install the charger.



Solar Charging cannot be used simultaneously with Static Load Management and Dynamic Load Management (2+ Chargers).
However, it is fully compatible with Dynamic Load Management.

Dynamic Load Management and Solar Charging

Place the energy meter after the mains supply and before the fuse box.

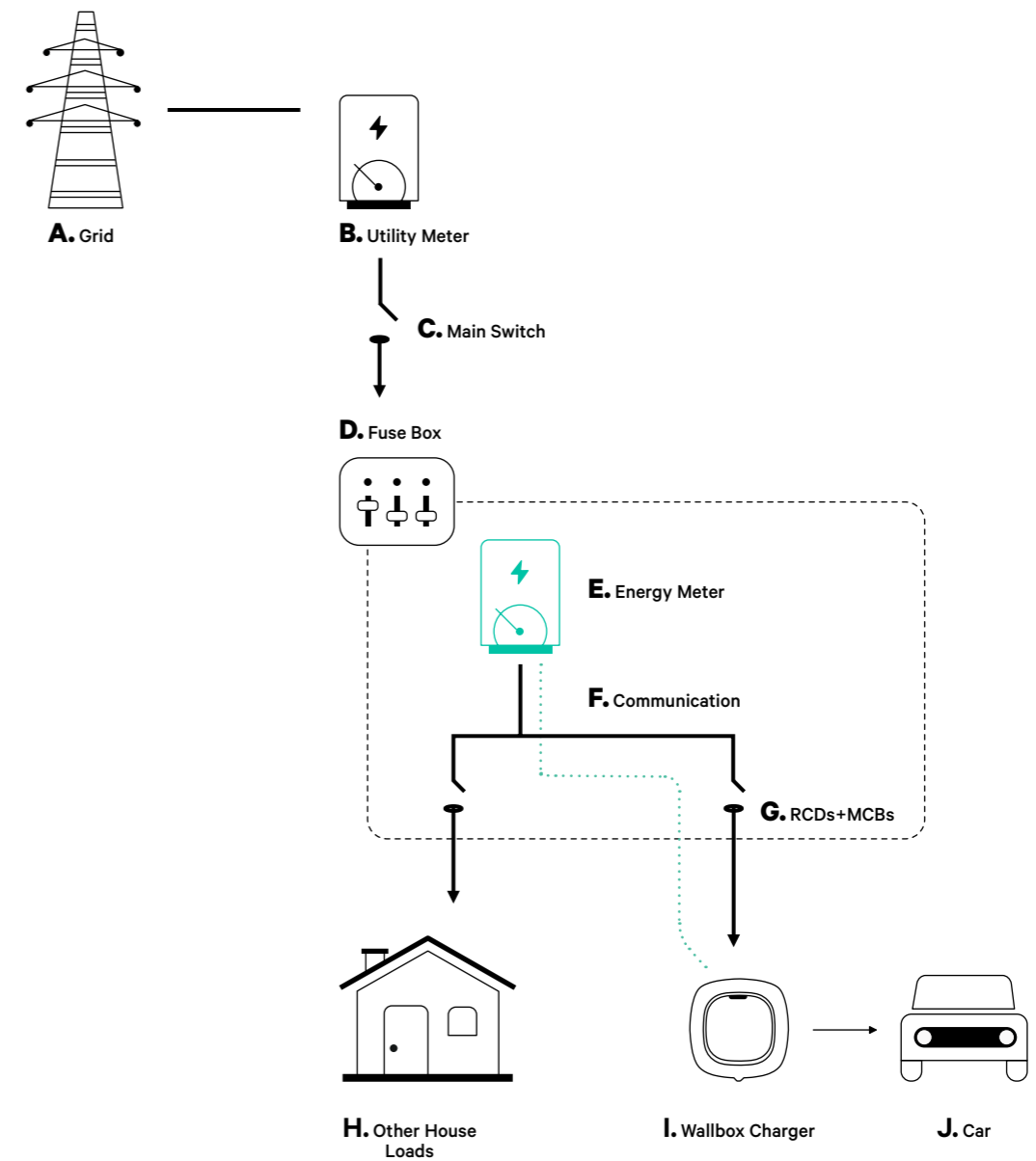

INSTALLATION WITH COMMANDER 2/2S

Dynamic Load Management and Solar Charging

Before Installation

- Ensure that the power is turned off during the installation.
- Separate the communication wires from the power ones.

Preparation

1. Remove the plastic knock-out at the bottom of the charger using a 25mm drill bit hole saw drill.

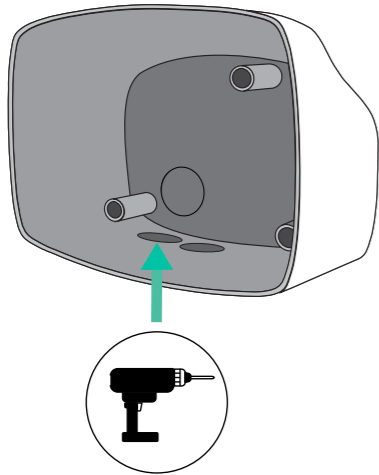

2. Using a flat screwdriver, make an incision in the 3-exit grommet. Remember, that you need to use only one hole of the 3-exit grommet by each communication line.

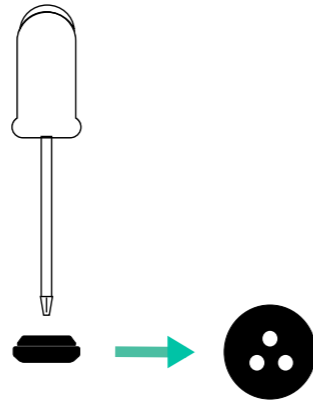

3. Insert the **grommet** in the hole at the bottom of the charger.

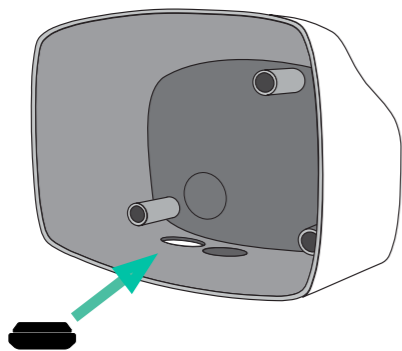

INSTALLATION WITH COMMANDER 2/2S

Dynamic Load Management and Solar Charging

Commander 2/2S Installation

Install the device following the instructions in the [Commander 2/2S Installation Guide](#).



Important

Ensure not to close the cover of the charger.

Communication wiring between the charger and the meter

1. Keep the power turned off during the installation.
2. Insert the communication wire through the grommet.

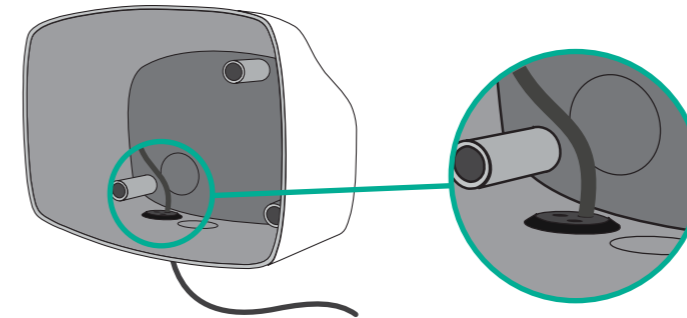

3. Install the meter following the instructions in the Meter Wiring Guide included in the package.
4. Wire the meter and the charger by following the relevant scheme below based on the model of your meter.



Important

It is mandatory to use an STP class 5E cable. Employ only 1 wire of each twisted pair and keep in mind that the communication wiring must not be more than 500m long.



Important

Insert only one cable for each grommet.

Dynamic Load Management and Solar Charging

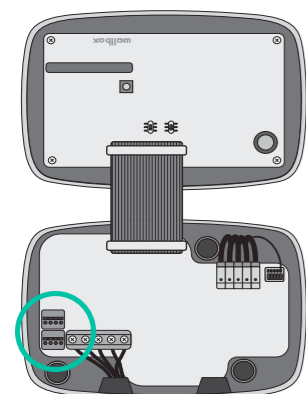

EM 112

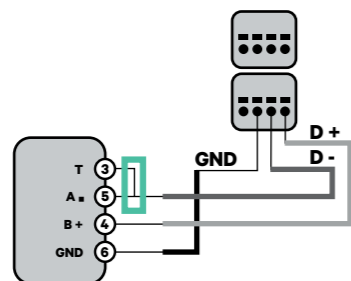

EM 340

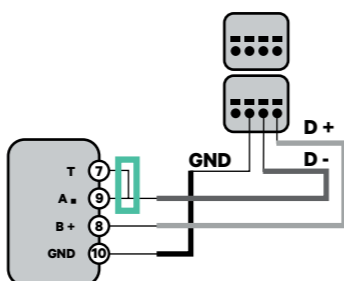

EM 330

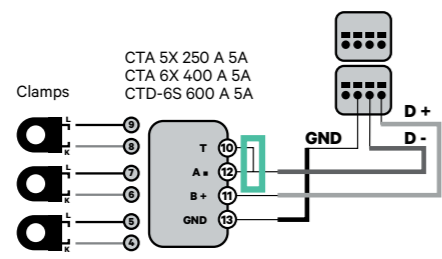
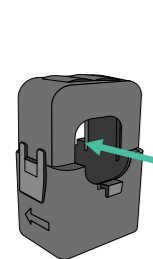

! For the EM330 configuration refer to the **Meter Configuration Guide** section.

N1 CT

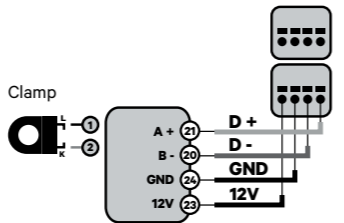

! For the N1CT installation, refer to the **Meter Configuration Guide** section.

P1 Port

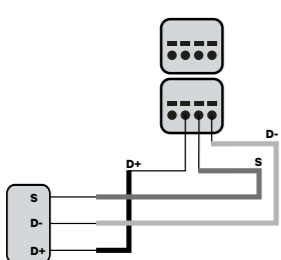

! For the P1 Port installation, refer to the **Meter Configuration Guide** section.

SPM1-100-AC

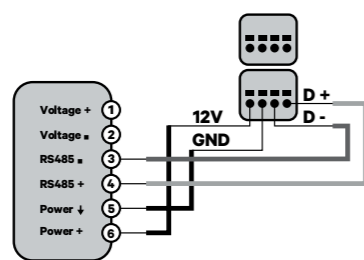

Pro MOD2

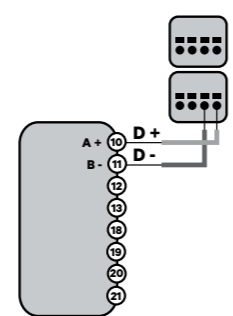

Pro 380 MOD

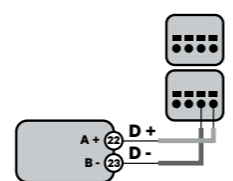

Important

Remember to check the **Meter Compatibility Table**.

Dynamic Load Management and Solar Charging

Terminating resistance activation and current selector configuration

1. Put the RS485 switch into position T.
2. Put the rotary switch into a position between 1 and 7, depending on the maximum current that can be supplied from the charging network.

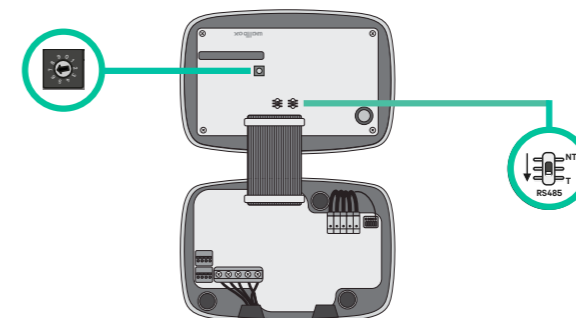

3. See the matrix below. This value must be equal or lower than the MCB protecting the Wallbox power line.

POSITION	0	1	2	3	4	5	6	7	8	9
CURRENT (A)	R	6	10	13	16	20	25	32	R	R

Note: Only Max Current > 6A per phase is accepted for a correct performance. In case of doubt, contact Wallbox Service.

4. Close the cover of the charger following the instructions in the charger's **Installation Guide**.

INSTALLATION WITH COMMANDER 2/2S Static Load Management

Tools

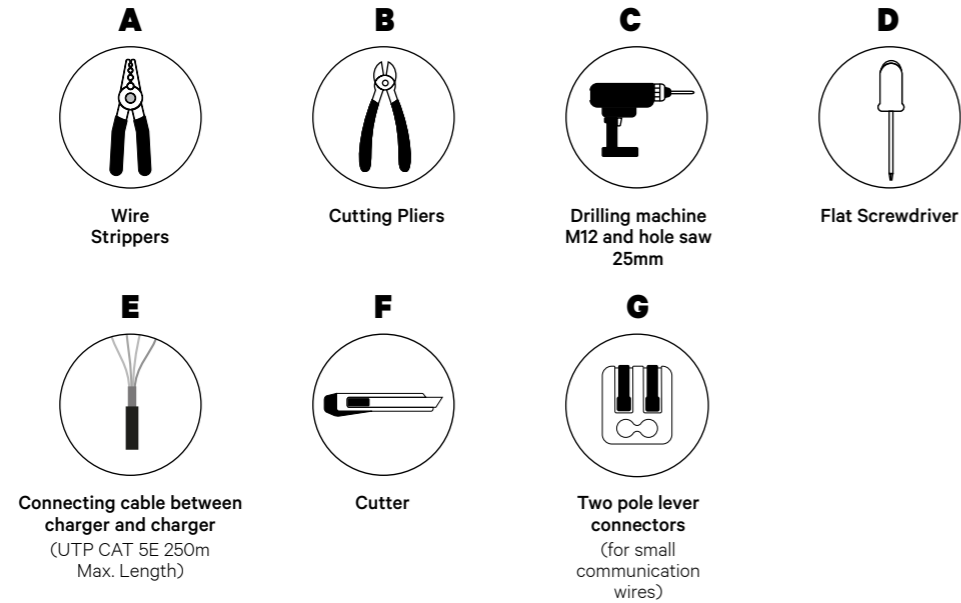

Refer to the **Commander 2/2S Installation Guide** to know more about the tools to install the charger.



Important

Please note that Static Load Management cannot be used simultaneously with Solar Charging. Ensure you choose the most suitable power management option for your needs.

INSTALLATION WITH COMMANDER 2/2S Static Load Management

Before Installation

- Ensure that the power is turned off during the installation.
- Separate the communication wires from the power ones.

Preparation

- 1.** Remove the plastic knock-out at the bottom of the charger using a 25mm drill bit hole saw drill.
- 2.** Using a flat screwdriver, make an incision in the 3-exit grommet. Remember, that you need to use only one hole of the 3-exit grommet by each communication line.

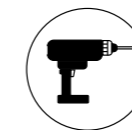
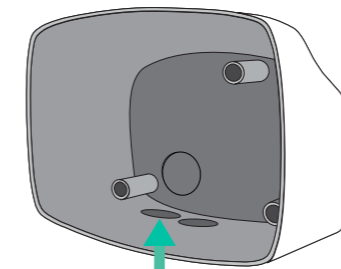

- 3.** Insert the **grommet** in the hole at the bottom of the charger.

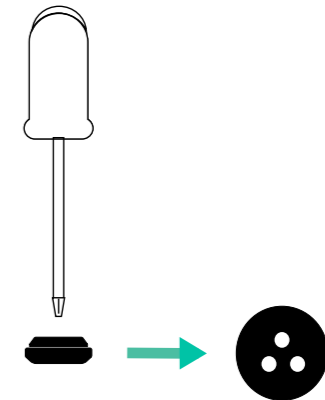
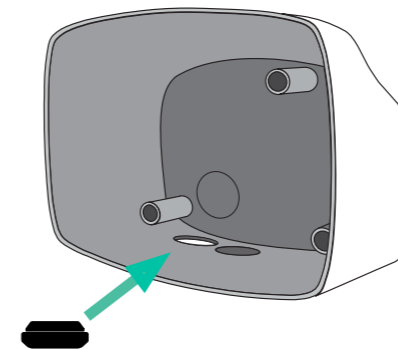

INSTALLATION WITH COMMANDER 2/2S Static Load Management

Commander 2/2S Installation

Install the charger following the instructions in the [Commander 2/2S Installation Guide](#).



Important

Ensure not to close the cover of the charger.

Wiring the system

1. Ensure that the power is turned off during the installation.
2. Insert the communication wire (UTP 5E cable) through the grommet.

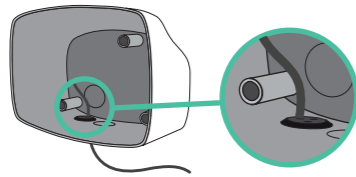

3. Check the position of CAN - L and CAN - H indicated above the connector.
Remember: the sequence in the connector can be different depending on each product.
4. Once located the connector, start cabling the primary charger (the first of the chain). Use a UTP 5E cable (a pair), then, insert one of the cables in CAN-L and the other in CAN-H. After, connect the other chargers of the chain following the scheme below. As you may notice, all the chargers have CAN-L and a CAN-H inputs and outputs, except for the first and the last ones.

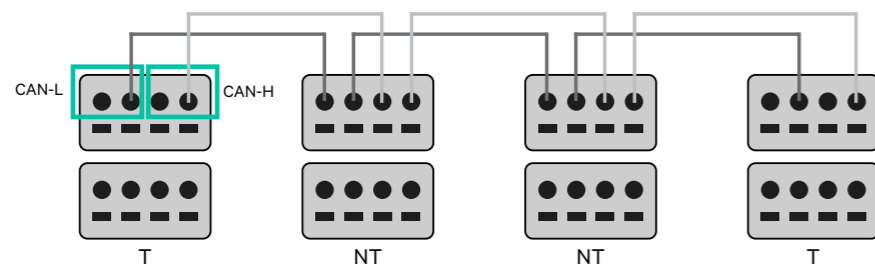

INSTALLATION WITH COMMANDER 2/2S Static Load Management



Important

- Make sure to connect each CAN-L to the respective CAN-L connector of all the chargers. Do the same for CAN-H.
- Static Load Management works up to 25 chargers for each installation. Among them, one is primary and 24 are secondary. The maximum distance the communication wiring can reach is 250m.

	CAN-L	CAN-H
CAN-L	✓	✗
CAN-H	✗	✓

Note: Only Max Current > 6A per phase is accepted for a correct performance. In case of doubts, contact Wallbox Service.

Refer to the charger's [Installation Guide](#) for more information.

Terminating settings

1. Once the cabling is completed, you need to activate the termination resistors. The first and the last charger will always be terminating (T) with non terminating (NT) chargers between them.

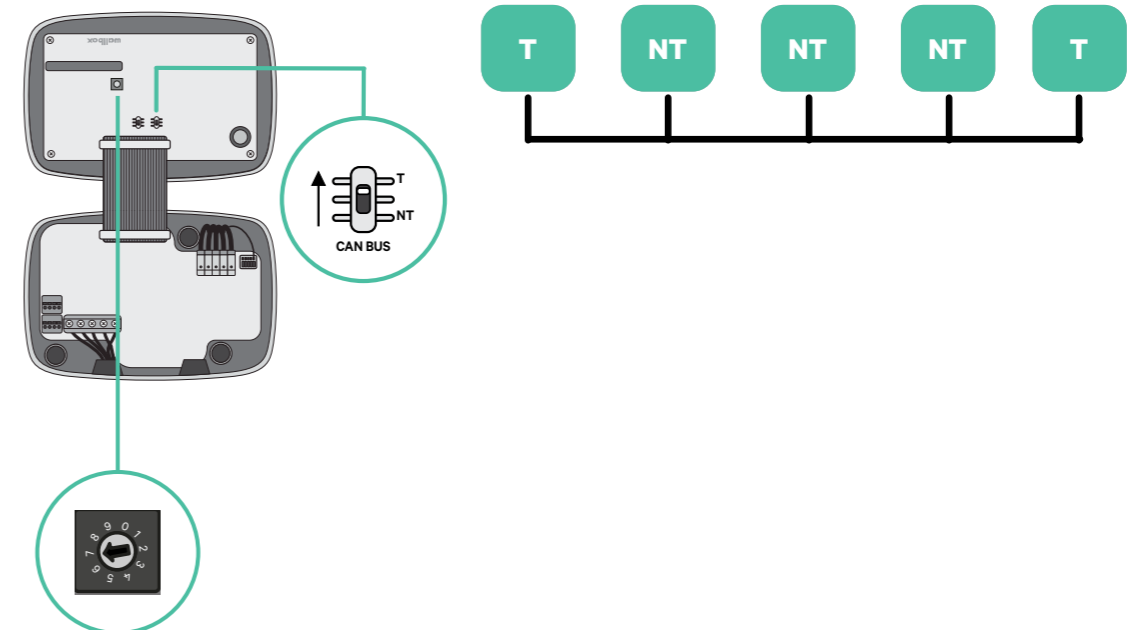

INSTALLATION WITH COMMANDER 2/2S Static Load Management

- 2.** Once the termination resistors are set up, place the current selector of each charger following the information. The first charger of the chain is the primary charger, the others are secondary.

The **primary charger** will be set on position 8 or 9.

The **secondary chargers** will be set on position 0.

POSITION	0	1	2	3	4	5	6	7	8	9
MAX CURRENT	*PS	6	10	13	16	20	25	32	*PS	*PS

- 3.** To ensure a proper set-up the measured **resistance between CAN-H and CAN-L must be near to 60 Ohms**. If it differs from that, recheck the proper wiring and the T/NT configuration.

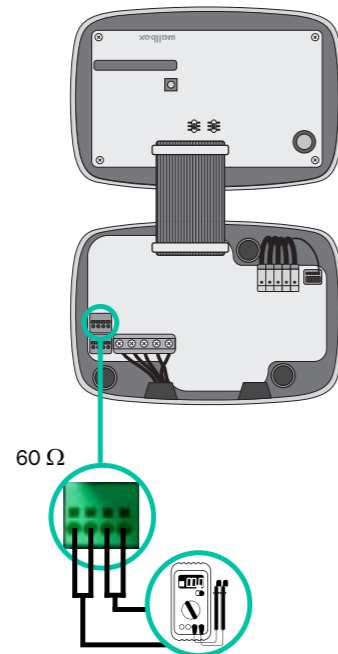

- 4.** Close the cover of your charger by following the instructions in the respective **Installation Guide**.

INSTALLATION WITH COMMANDER 2/2S Static Load Management

Adding chargers in the future:

If you anticipate adding chargers to the system in the future, there are two ways you can prepare the system now to make it ready for Static Load Management.

Option 1: Place a bus disconnecter to accommodate future chargers as shown in the option 1 wiring scheme below. This option avoids the need of reopening the existing chargers and hence it is the recommended option.

Option 2: Truncate the existing bus to add new charger(s) as shown in the option 2 wiring scheme below.

1. Open the charger following the installation guide of your Commander 2/2S charger.
2. Set the terminating resistance into NT, make the communication wiring as explained above and then close the charger.



Important

New chargers may be placed anywhere physically in relation to the existing chargers as long as you follow these rules:

- You maintain the logic of the daisy chain.
- You respect the cabling polarity as described above under “Installation”.

Wherever a future added charger is placed, the most important rule to follow is the logic of the daisy chain. For example, in the image below, the new charger is placed before the Terminating charger on the right side of the daisy chain.

Option 1:

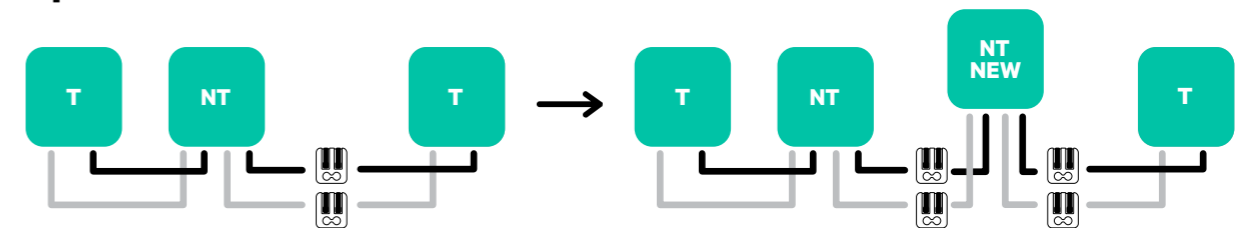

Option 2:

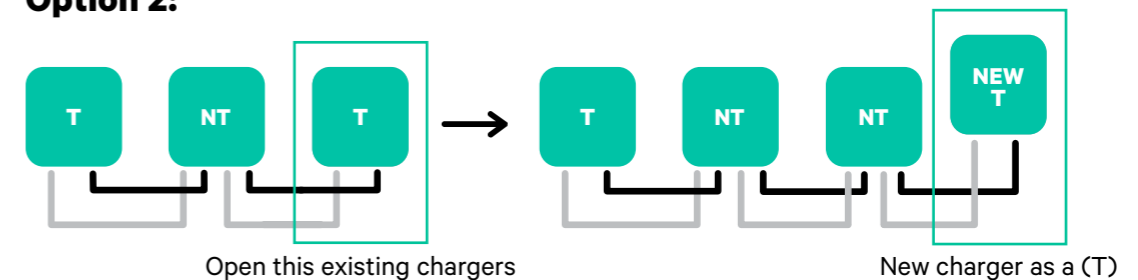

INSTALLATION WITH COMMANDER 2/2S

Dynamic Load Management (2+ Chargers)

Tools

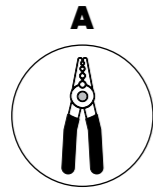

Wire Strippers

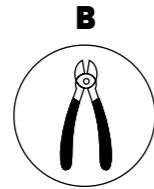

Cutting Pliers

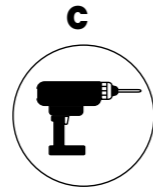

Drilling machine
M12 and hole saw
25mm

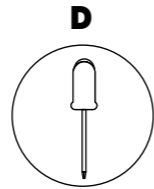

Flat Screwdriver

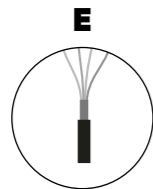

Connecting cable between
charger and meter
(STP Class 5E
500m Max Length)

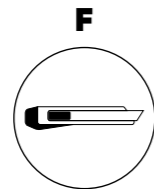

Cutter

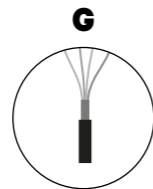

Connecting cable between
charger and charger
(UTP CAT 5E
250m Max Length)

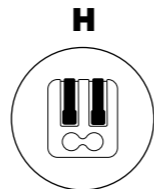

Two pole lever
connectors
(for small
communication
wires)

Refer to the [Commander 2/2S Installation Guide](#) to know more about the tools to install the charger.



Important

Please note that **Dynamic Load Management (2+ Chargers)** cannot be used simultaneously with **Solar Charging**. Ensure you choose the most suitable power management option for your needs.

INSTALLATION WITH COMMANDER 2/2S

Dynamic Load Management (2+ Chargers)

Before Installation

- Ensure that the power is turned off during the installation.
- Separate the communication wires from the power ones.

Preparation

1. Remove the plastic knock-out at the bottom of the charger using a 25mm drill bit hole saw.

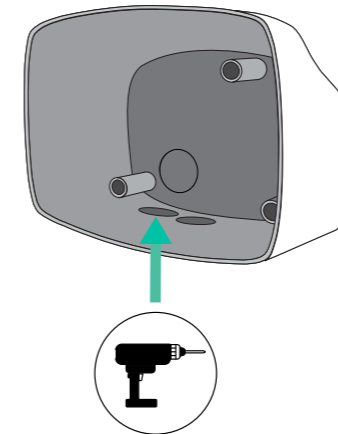

2. Using a flat screwdriver, make an incision in the 3-exit grommet. Remember, that you need to use only one hole of the 3-exit grommet by each communication line.

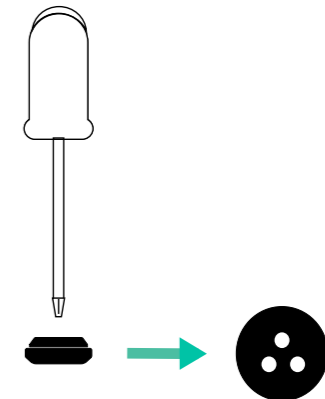

3. Insert the grommet in the bottom hole of the charger.

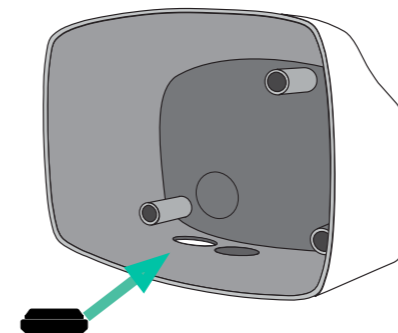

INSTALLATION WITH COMMANDER 2/2S

Dynamic Load Management (2+ Chargers)

Commander 2/2S Installation

Install the device following the instructions in the [Commander 2/2S Installation Guide](#).



Important

Ensure not to close the cover of the charger.

Communication wiring between the charger and the meter

1. Keep the power turned off during the installation.
2. Insert through the grommet the two communication wires, one for meter communication and the other one for communication between chargers.

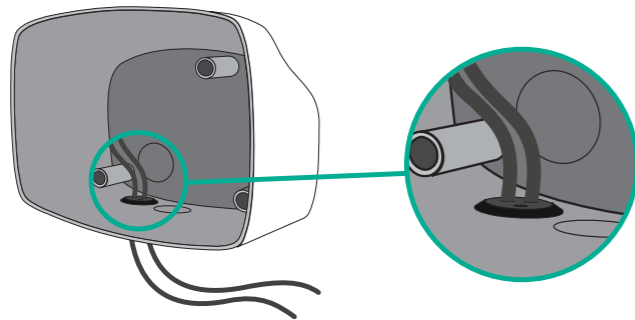

3. Install the meter following the instructions in the Meter Wiring Guide included in the package.
4. Wire the meter and the charger by following the relevant scheme below based on the model of your meter.



Important

It is mandatory to use an STP class 5E cable. Employ only 1 wire of each twisted pair and keep in mind that the communication wiring must not be more than 500m long.



Important

Insert only one cable for each grommet.

INSTALLATION WITH COMMANDER 2/2S

Dynamic Load Management (2+ Chargers)

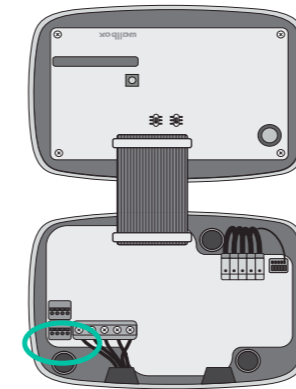

EM 112

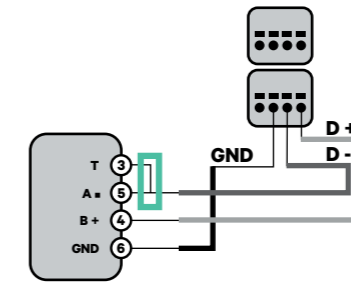

EM 340

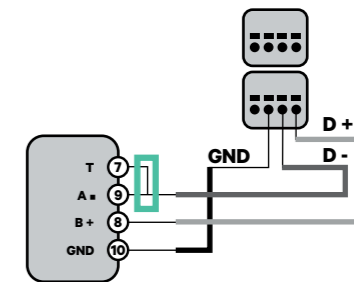

EM 330

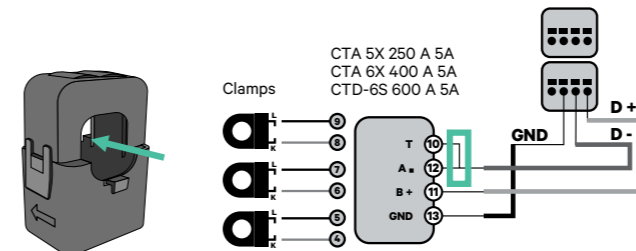

! For the EM330 configuration refer to the refer to the [Meter Configuration Guide](#) section.

N1 CT

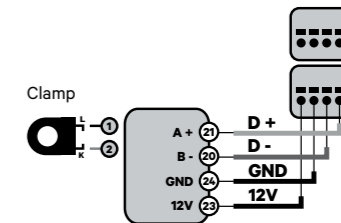

! For the N1CT installation, refer to the refer to the [Meter Configuration Guide](#) section.

P1 Port

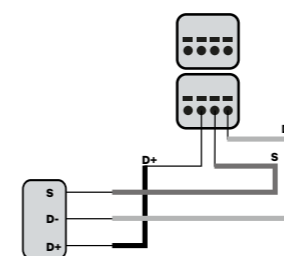

SPM1-100-AC

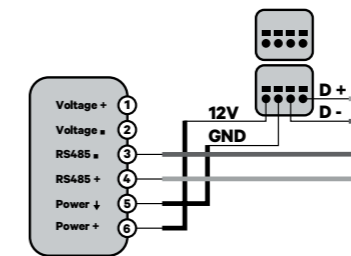

! For the P1 Port installation, refer to the refer to the [Meter Configuration Guide](#) section.

Pro MOD2

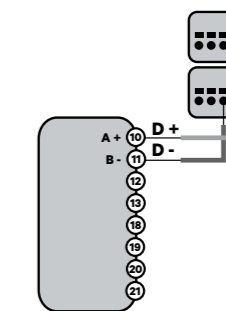

Pro 380 MOD

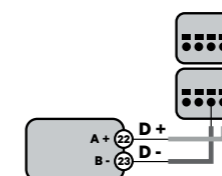

Dynamic Load Management (2+ Chargers)

Wiring the system

1. Ensure that the power is turned off during the installation.
2. Check the position of CAN - L and CAN - H indicated above the connector.
Remember: the sequence in the connector can be different depending on each product.
3. Once located the connector, start cabling the primary charger (the first of the chain). Use a UTP 5E cable (a pair), then, insert one of the cables in CAN-L and the other in CAN-H. After, connect the other chargers of the chain following the scheme below. As you may notice, all the chargers have CAN-L and a CAN-H inputs and outputs, except for the first and the last ones.

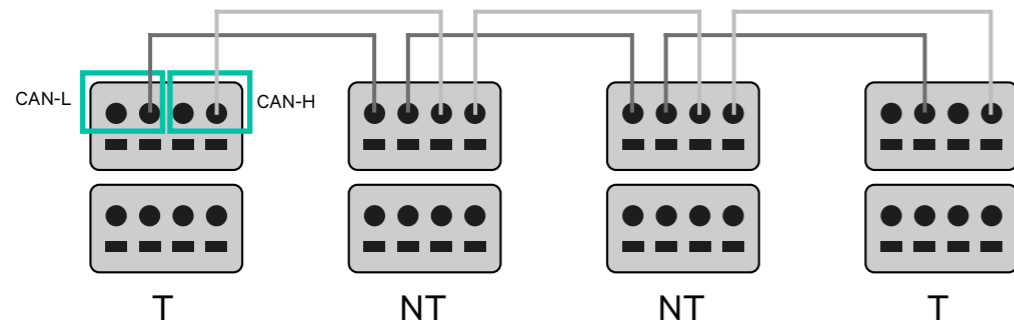

Important

- Make sure to connect each CAN-L to the respective CAN-L connector of all the chargers. Do the same for CAN-H.
- Static Load Management works up to 25 chargers for each installation. Among them, one is primary and 24 are secondary. The maximum distance the communication wiring can reach is 250m.

	CAN-L	CAN-H
CAN-L	✓	×
CAN-H	×	✓

Note: Only Max Current > 6A per phase is accepted for a correct performance. In case of doubts, contact Wallbox Service.

Dynamic Load Management (2+ Chargers)

Terminating settings

1. Once the cabling is complete, you need to activate the terminating resistors. First set up RS485 into T only for the charger that is connected into meter. Then set up the CAN BUS, the first and the last charger will always be terminating (T) with non terminating (NT) chargers between them.

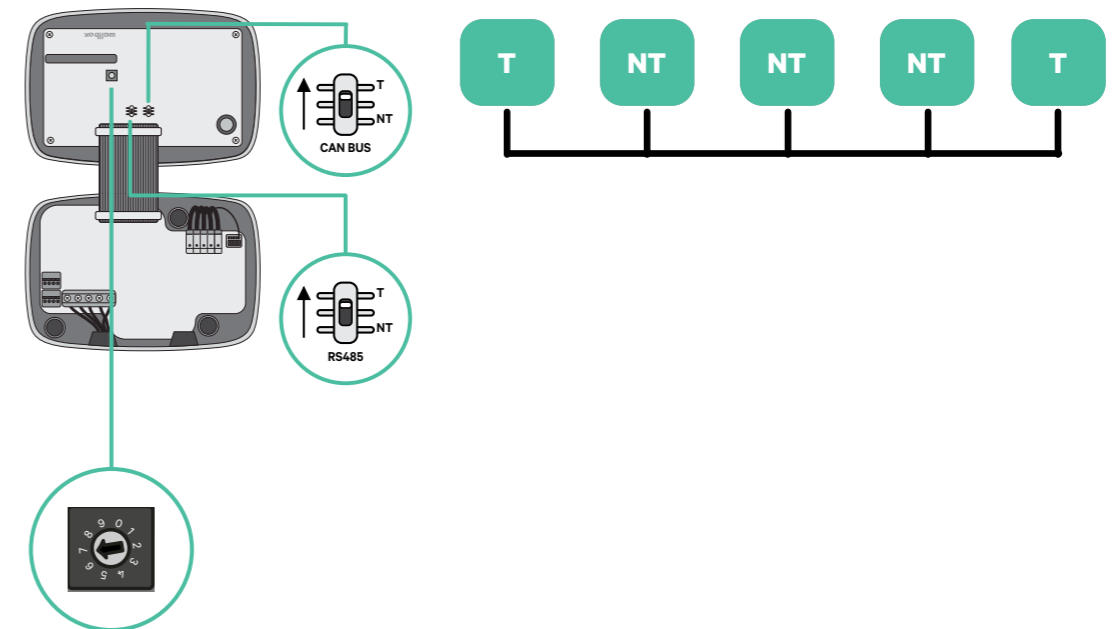

2. Once the termination resistors are set up, place the current selector of each charger following the information. The first charger of the chain is the primary charger, the others are secondary.

The **primary charger** will be set on position 8 or 9.

The **secondary chargers** will be set on position 0.

POSITION	0	1	2	3	4	5	6	7	8	9
MAX CURRENT	*PS	6	10	13	16	20	25	32	*PS*	*PS*

INSTALLATION WITH COMMANDER 2/2S

Dynamic Load Management (2+ Chargers)

- 3.** To ensure a proper set-up the measured **resistance between CAN-H and CAN-L must be near to 60 Ohms**. If it differs from that, recheck the proper wiring and the T/NT configuration.

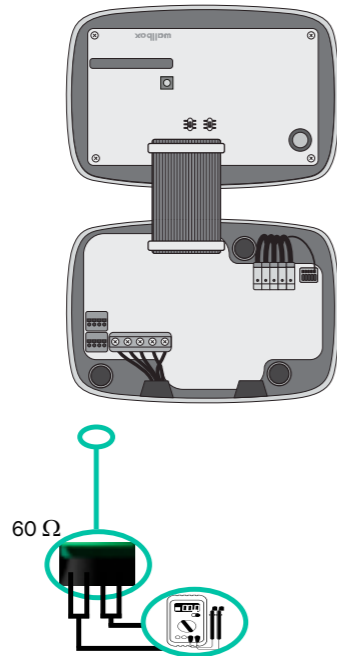

- 4.** Close the cover of your charger by following the instructions in the respective **Installation Guide**.

INSTALLATION WITH COMMANDER 2/2S

Dynamic Load Management (2+ Chargers)

Exemple of an installation with four chargers (CAN-Bus)

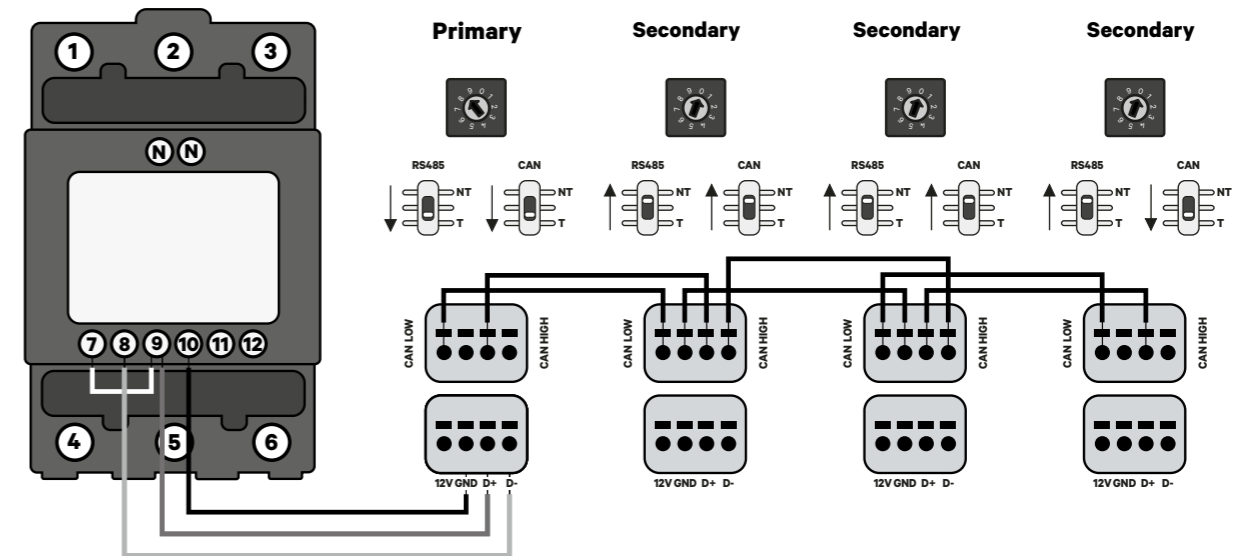

Adding chargers in the future:

If you anticipate adding chargers to the system in the future, there are two ways you can prepare the system now to make it ready for Dynamic Load Management (2+ Chargers).

Option 1: Place a bus disconnector to accommodate future chargers as shown in the option 1 wiring scheme below. This option avoids the need of reopening the existing chargers and hence it is the recommended option.

Option 2: Truncate the existing bus to add new charger(s) as shown in the option 2 wiring scheme below.

1. Open the charger following the installation guide of your Commander 2/2S charger.
2. Set the terminating resistance into NT, make the communication wiring as explained above and then close the charger.



Important

New chargers may be placed anywhere physically in relation to the existing chargers as long as you follow these rules:

- You maintain the logic of the daisy chain.
- You respect the cabling polarity as described above under “Installation”.

INSTALLATION WITH COMMANDER 2/2S

Dynamic Load Management (2+ Chargers)

Wherever a future added charger is placed, the most important rule to follow is the logic of the daisy chain. For example, in the image below, the new charger is placed before the Terminating charger on the right side of the daisy chain.

Option 1:

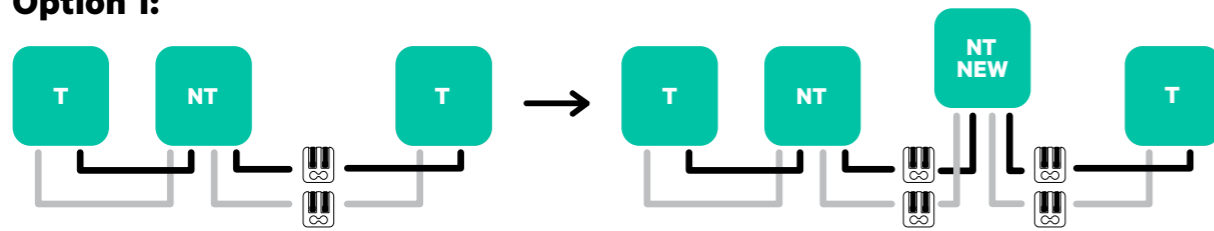

Option 2:

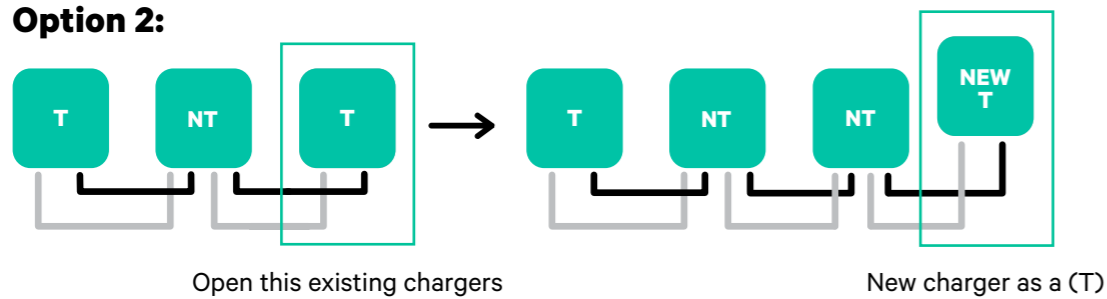

Once you finish the extension of the existing installation, continue with steps on the next page for setting up the chargers.

INSTALLATION WITH COPPER SB

Dynamic Load Management and Solar Charging

Tools

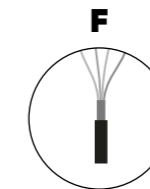
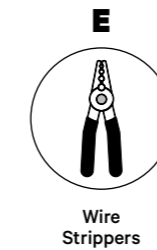
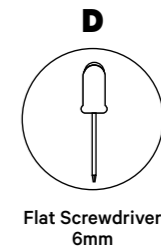
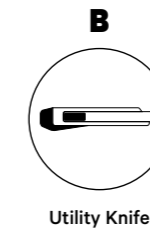
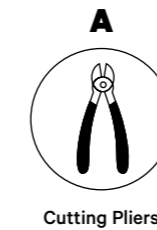

Refer to the [Copper SB Installation Guide](#) to know more about the tools to install the charger.

INSTALLATION WITH COPPER SB

Dynamic Load Management and Solar Charging

Place the energy meter after the mains supply and before the fuse box.

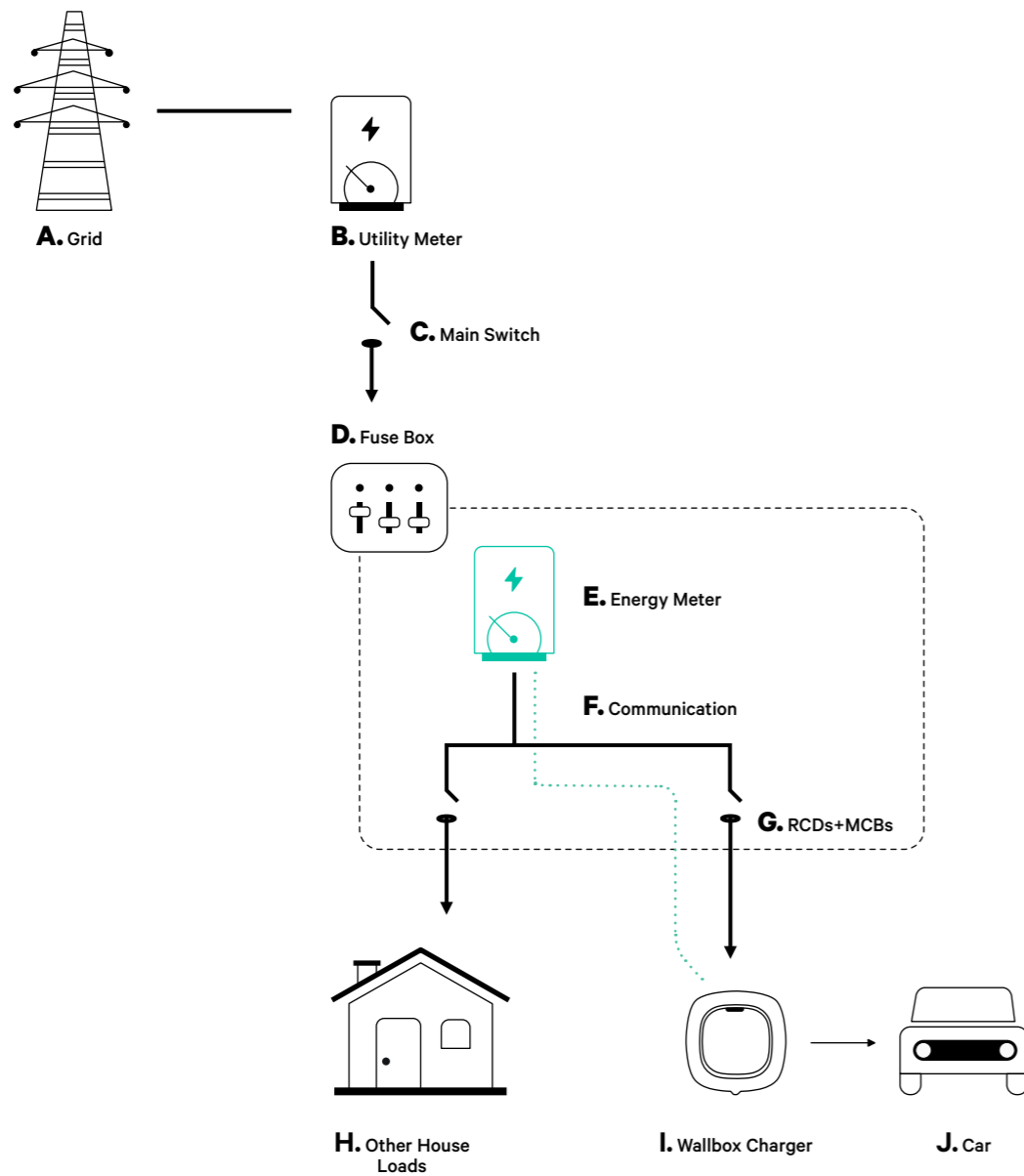

INSTALLATION WITH COPPER SB

Dynamic Load Management and Solar Charging

Before Installation

- Ensure that the power is turned off during the installation.
- Separate the communication wires from the power ones.

Preparation

- 1.** Remove the plastic knock-out at the bottom of the charger using an M12 drill bit.

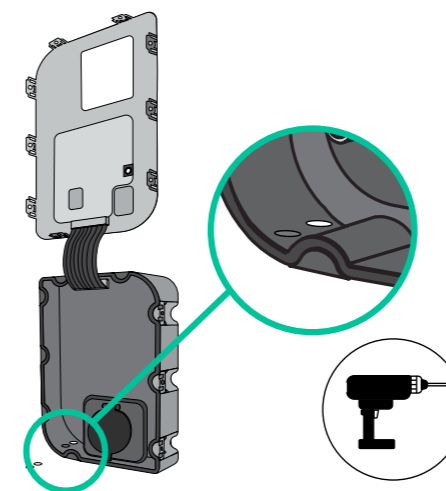

- 2.** Make a hole in the grommet using a flat screw driver.

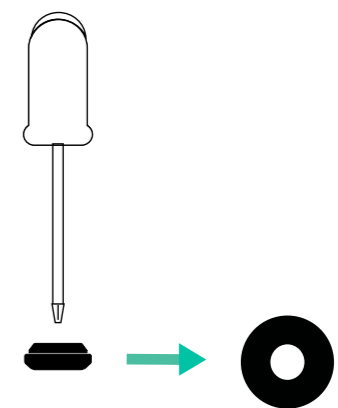

- 3.** Insert the **grommet** in the hole at the bottom of the charger.

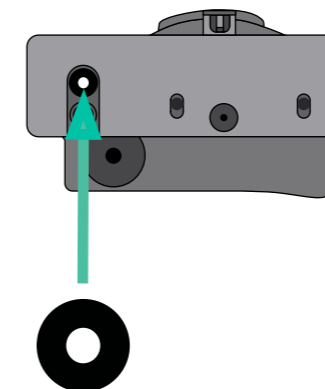

INSTALLATION WITH COPPER SB

Dynamic Load Management and Solar Charging

Copper SB Installation

Install the device following the instructions in the [Copper SB Installation Guide](#).



Important

Ensure not to close the cover of the charger.

Communication wiring between the charger and the meter

1. Keep the power turned off during the installation.
2. Insert the communication wire through the grommet.

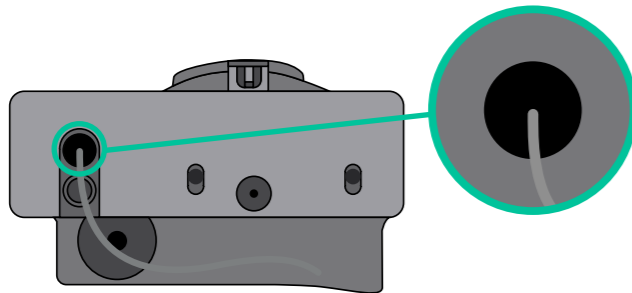

3. Install the meter following the instructions in the Meter Wiring Guide included in the package.
4. Wire the meter and the charger by following the relevant scheme below based on the model of your meter.



Important

It is mandatory to use an STP class 5E cable. Employ only 1 wire of each twisted pair and keep in mind that the communication wiring must not be more than 500m long.



Important

Insert only one cable for each grommet.

INSTALLATION WITH COPPER SB

Dynamic Load Management and Solar Charging

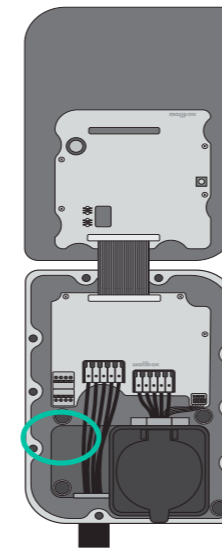

EM 112

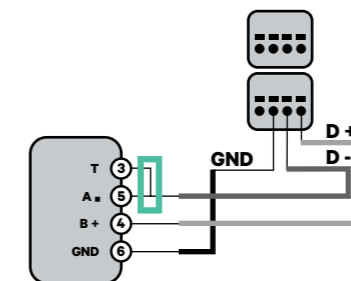

EM 340

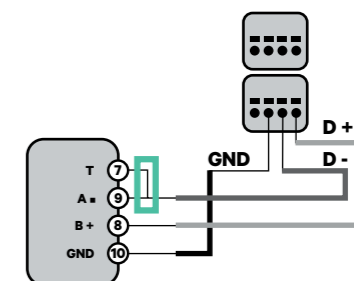

EM 330

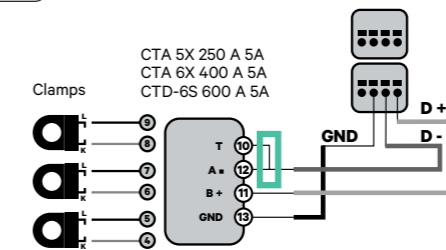

N1 CT

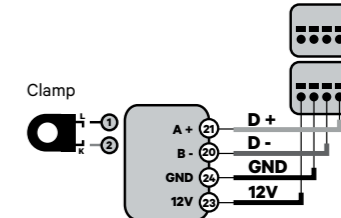

! For the EM330 configuration, refer to the [Meter Configuration Guide](#) section.

! For the N1CT installation, refer to the [Meter Configuration Guide](#) section.

P1 Port

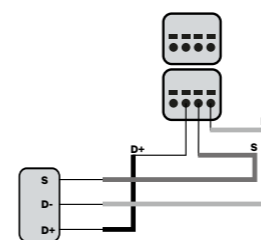

SPM1-100-AC

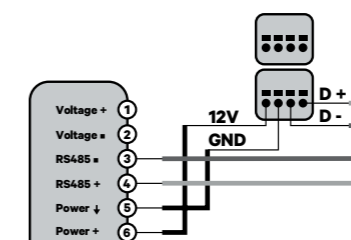

! For the P1 Port installation, refer to the [Meter Configuration Guide](#) section.

Pro MOD2

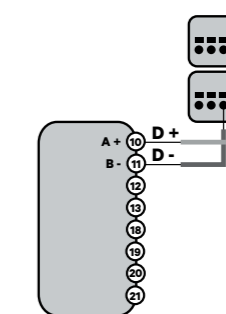

Pro 380 MOD

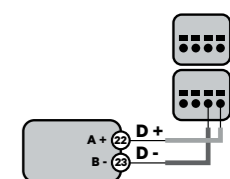

Important

Remember to check the [Meter Compatibility Table](#).

Dynamic Load Management and Solar Charging

Terminating resistance activation and current selector configuration

1. Put the RS485 switch into position T.
2. Put the rotary switch into a position between 1 and 7, depending on the maximum current that can be supplied from the charging network.

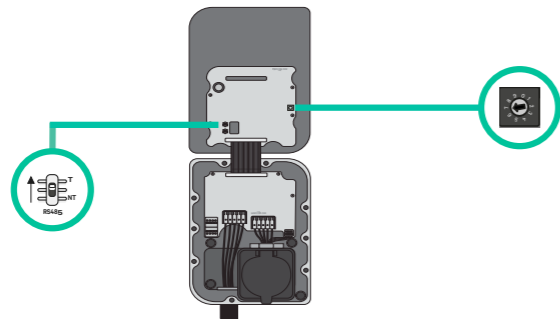

3. See the matrix below. This value must be equal or lower than the MCB protecting the Wallbox power line.

POSITION	0	1	2	3	4	5	6	7	8	9
CURRENT (A)	R	6	10	13	16	20	25	32	R	R

Note: Only Max Current > 6A per phase is accepted for a correct performance. In case of doubts, contact Wallbox Service.

4. Close the cover of the charger following the instructions in the charger's **Installation Guide**.

Static Load Management

Tools

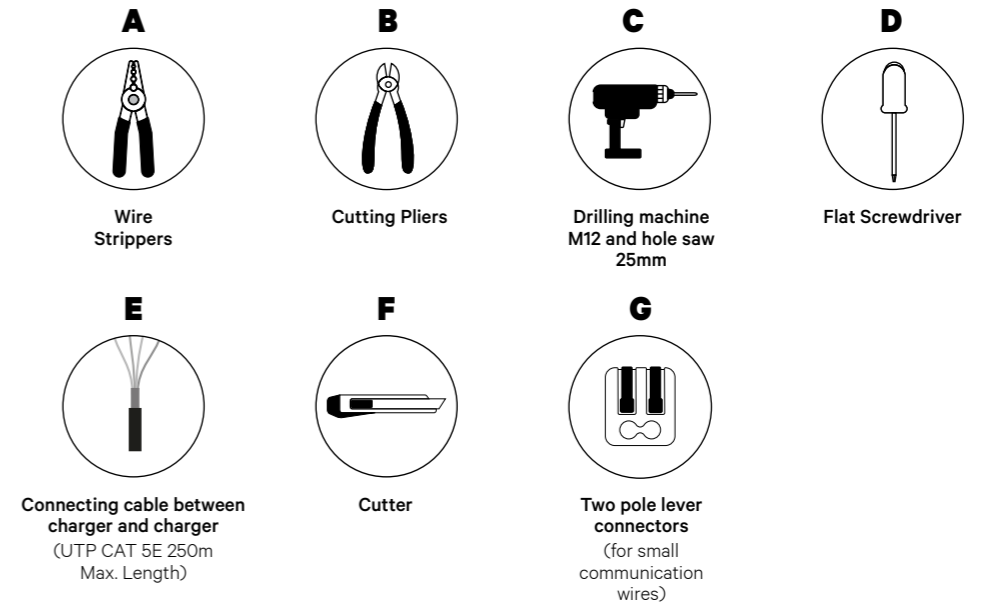

Refer to the **Copper SB Installation Guide** to know more about the tools to install the charger.



Important

Please note that Static Load Management cannot be used simultaneously with Solar Charging. Ensure you choose the most suitable power management option for your needs.

INSTALLATION WITH COPPER SB Static Load Management

Before Installation

- Ensure that the power is turned off during the installation.
- Separate the communication wires from the power ones.

Preparation

1. Open the cover of the charger by following the instructions in **Copper SB Installation Guide**.

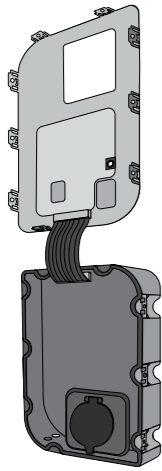

2. Remove the plastic knock-out at the bottom of the charger using an M12 drill bit.

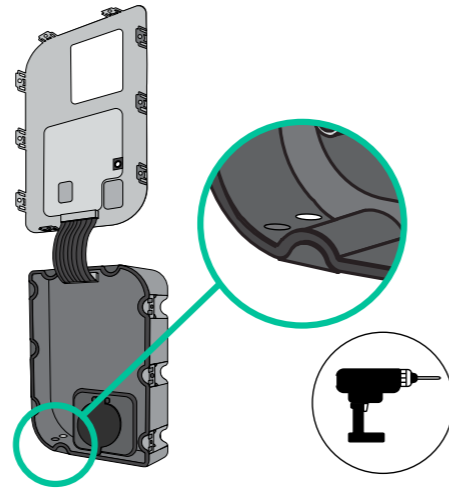

3. Make a hole in the grommet using a flat screw driver.

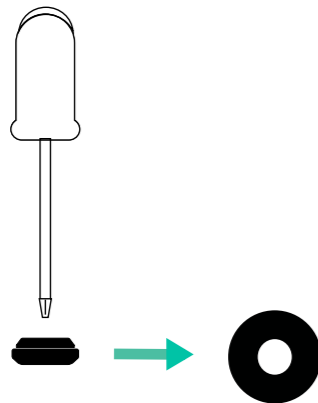

4. Insert the **grommet** in the hole at the bottom of the charger.

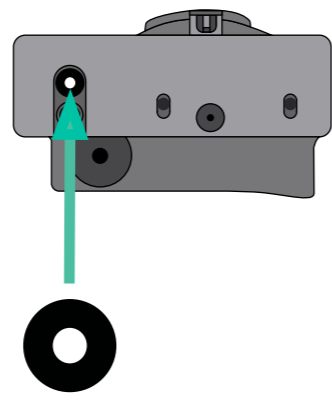

Copper SB Installation

Install the charger following the instructions in the **Copper SB Installation Guide**.



Important

Ensure not to close the cover of the charger.

INSTALLATION WITH COPPER SB Static Load Management

Wiring the system

1. Ensure that the power is turned off during the installation.
2. Insert the communication wire (UTP 5E cable) through the grommet.

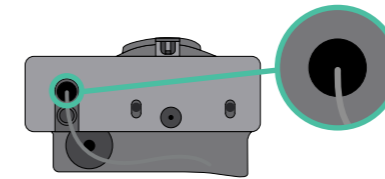

3. Check the position of CAN - L and CAN - H indicated above the connector. **Remember:** the sequence in the connector can be different depending on each product.

4. Once located the connector, start cabling the primary charger (the first of the chain). Use a UTP 5E cable (a pair), then, insert one of the cables in CAN-L and the other in CAN-H. After, connect the other chargers of the chain following the scheme below. As you may notice, all the chargers have CAN-L and a CAN-H inputs and outputs, except for the first and the last ones.

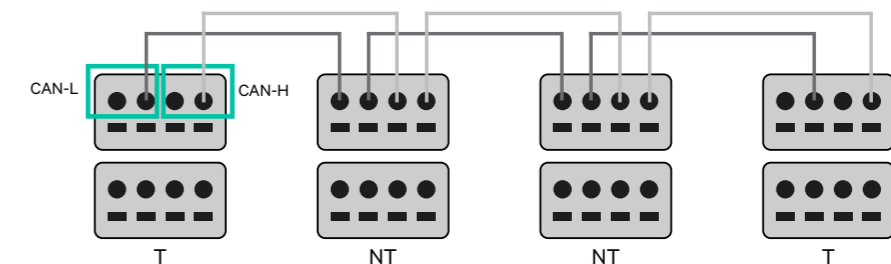

Important

- Make sure to connect each CAN-L to the respective CAN-L connector of all the chargers. Do the same for CAN-H.
- Static Load Management works up to 25 chargers for each installation. Among them, one is primary and 24 are secondary. The maximum distance the communication wiring can reach is 250m.

	CAN-L	CAN-H
CAN-L	✓	×
CAN-H	×	✓

Note: Only Max Current > 6A per phase is accepted for a correct performance. In case of doubts, contact Wallbox Service.

INSTALLATION WITH COPPER SB Static Load Management

Terminating settings

1. Once the cabling is completed, you need to activate the termination resistors. The first and the last charger will always be terminating (T) with non terminating (NT) chargers between them.

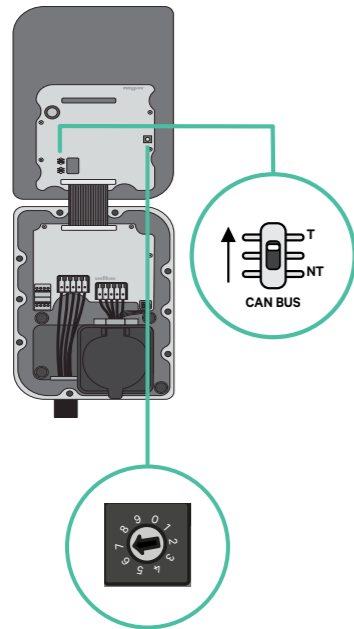
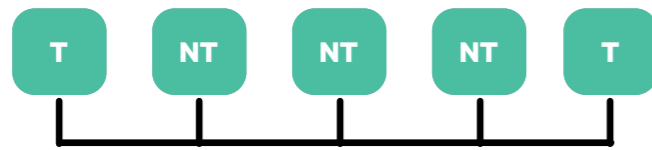

INSTALLATION WITH COPPER SB Static Load Management

2. Once the termination resistors are set up, place the current selector of each charger following the information. The first charger of the chain is the primary charger, the others are secondary.

The **primary charger** will be set on position 8 or 9.

The **secondary chargers** will be set on position 0.

POSITION	0	1	2	3	4	5	6	7	8	9
MAX CURRENT	*PS	6	10	13	16	20	25	32	*PS	*PS

3. To ensure a proper set-up the measured **resistance between CAN-H and CAN-L must be near to 60 Ohms**. If it differs from that, recheck the proper wiring and the T/NT configuration.

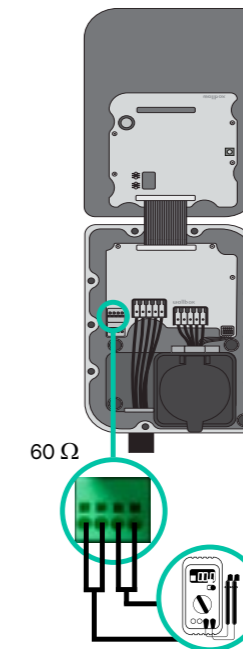

4. Close the cover of the charger following the instructions in the respective **Installation Guide**.

INSTALLATION WITH COPPER SB

Static Load Management

Adding chargers in the future:

If you anticipate adding chargers to the system in the future, there are two ways you can prepare the system now to make it ready for Static Load Management.

Option 1: Place a bus disconnecter to accommodate future chargers as shown in the option 1 wiring scheme below. This option avoids the need of reopening the existing chargers and hence it is the recommended option.

Option 2: Truncate the existing bus to add new charger(s) as shown in the option 2 wiring scheme below.

1. Open the charger following the installation guide of your Copper SB charger.
2. Set the terminating resistance into NT, make the communication wiring as explained above and then close the charger.



Important

New chargers may be placed anywhere physically in relation to the existing chargers as long as you follow these rules:

- You maintain the logic of the daisy chain.
- You respect the cabling polarity as described above under “Installation”.

Wherever a future added charger is placed, the most important rule to follow is the logic of the daisy chain. For example, in the image below, the new charger is placed before the Terminating charger on the right side of the daisy chain.

Option 1:

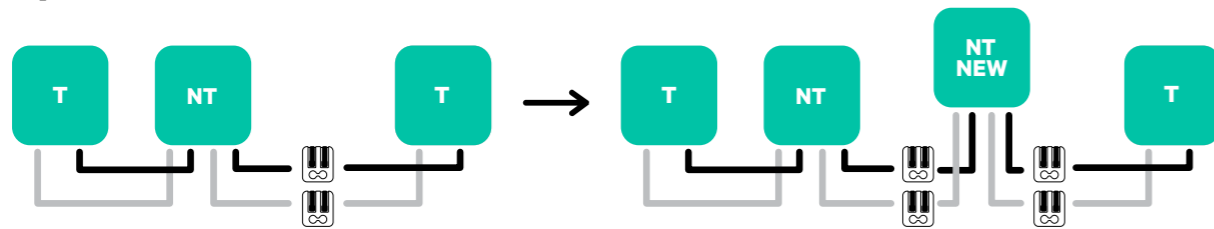

Option 2:

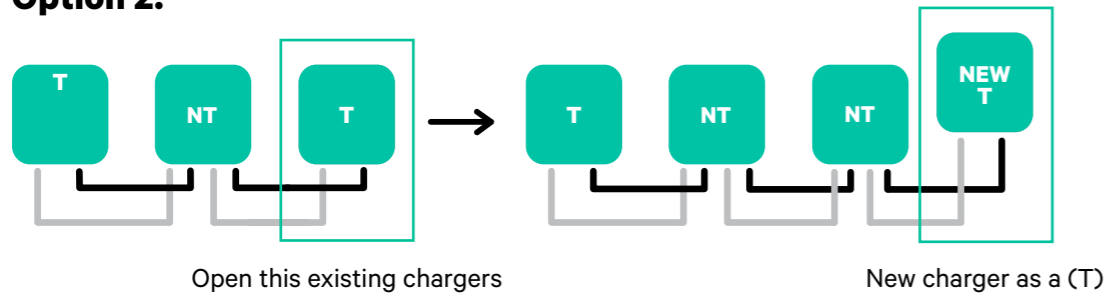

INSTALLATION WITH COPPER SB

Dynamic Load Management (2+ Chargers)

Tools

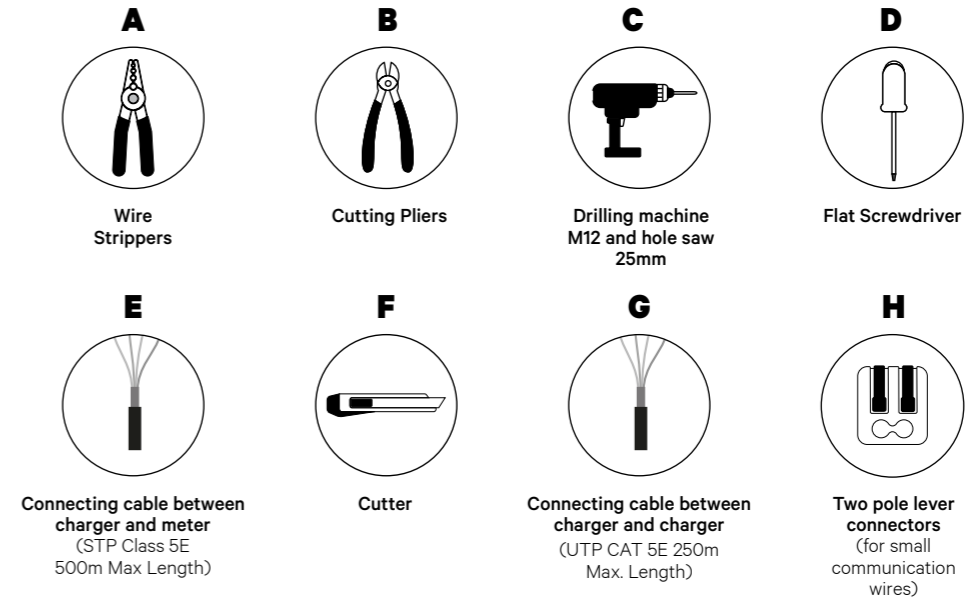

Refer to the [Copper SB Installation Guide](#) to know more about the tools to install the charger.



Important

Please note that **Dynamic Load Management (2+ Chargers)** cannot be used **simultaneously with Solar Charging**. Ensure you choose the most suitable power management option for your needs.

INSTALLATION WITH COPPER SB

Dynamic Load Management (2+ Chargers)

Before Installation

- Ensure that the power is turned off during the installation.
- Separate the communication wires from the power ones.

Preparation

- 1.** Open the cover of the charger by following the instructions in **Copper SB Installation Guide**.

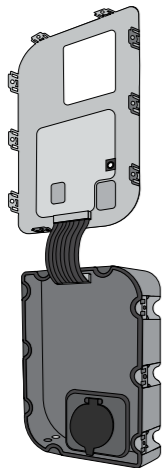

- 2.** Remove the plastic knock-out at the bottom of the charger using an M12 drill bit.

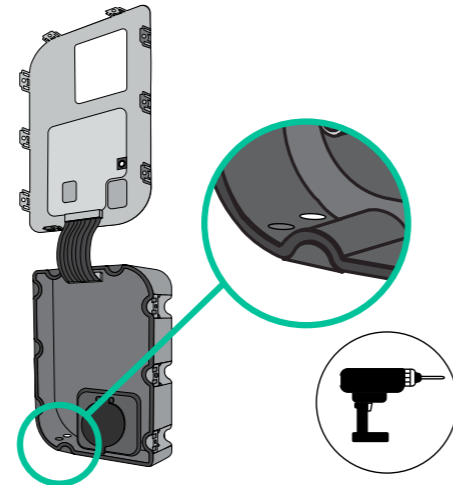

- 3.** Make a hole in the grommet using a flat screw driver.

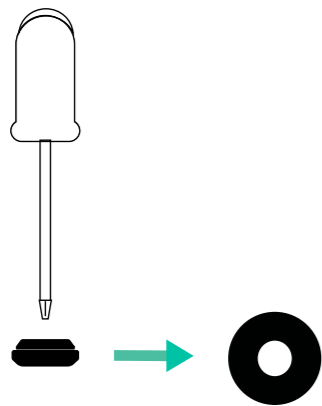

- 4.** Insert the **grommet** in the hole at the bottom of the charger.

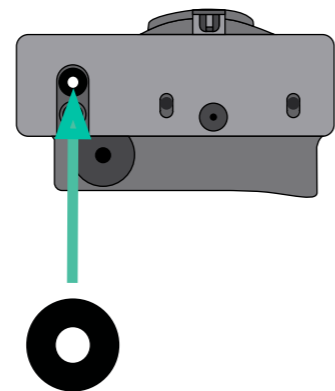

INSTALLATION WITH COPPER SB

Dynamic Load Management (2+ Chargers)

Copper SB Installation

Install the device following the instructions in the **Copper SB Installation Guide**.



Important

Ensure not to close the cover of the charger.

Communication wiring between the charger and the meter

- 1.** Keep the power turned off during the installation.
- 2.** Insert through the grommet the two communication wires, one for meter communication and the other one for communication between chargers.

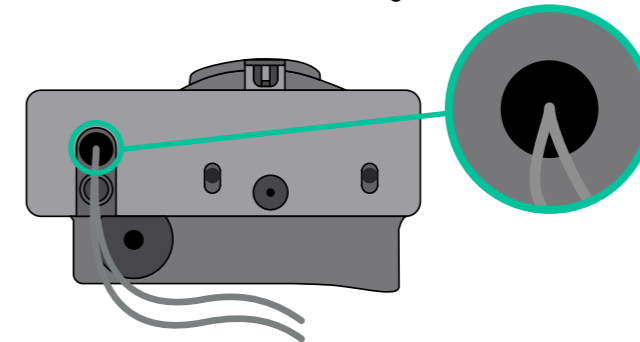

- 3.** Install the meter following the instructions in the Meter Wiring Guide included in the package.
- 4.** Wire the meter and the charger by following the relevant scheme below based on the model of your meter.



Important

It is mandatory to use an STP class 5E cable. Employ only 1 wire of each twisted pair and keep in mind that the communication wiring must not be more than 500m long.

INSTALLATION WITH COPPER SB

Dynamic Load Management (2+ Chargers)

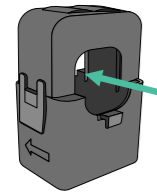
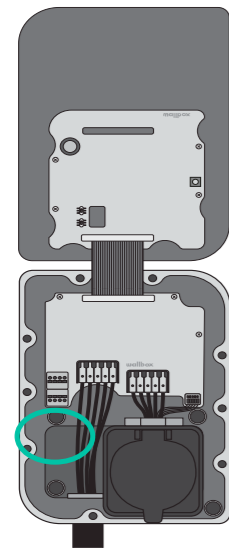

EM 112

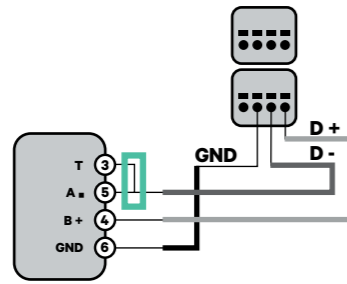

EM 340

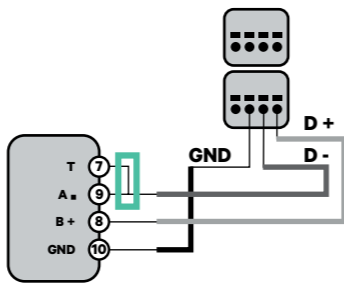

EM 330

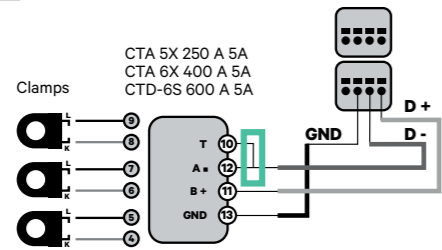

! For the EM330 configuration refer to the refer to the **Meter Configuration Guide** section.

N1 CT

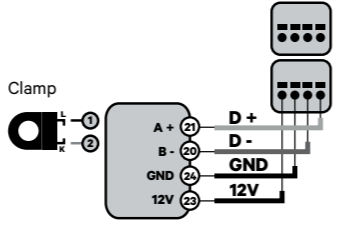

! For the N1CT installation, refer to the refer to the **Meter Configuration Guide** section.

P1 Port

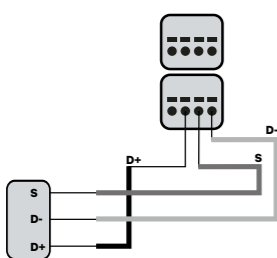

! For the P1 Port installation, refer to the refer to the **Meter Configuration Guide** section.

SPM1-100-AC

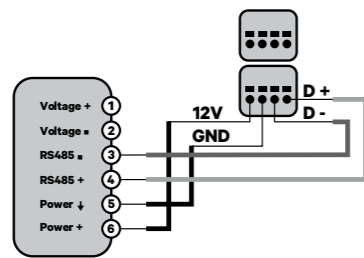

Pro MOD2

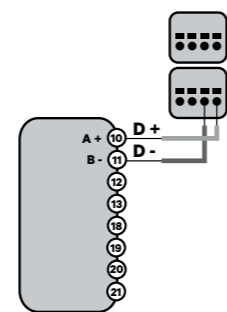

Pro 380 MOD

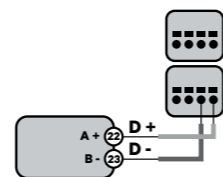

Important

Remember to check the **Meter Compatibility Table**.

INSTALLATION WITH COPPER SB

Dynamic Load Management (2+ Chargers)

Wiring the system

1. Ensure that the power is turned off during the installation.
2. Check the position of CAN - L and CAN - H indicated above the connector. **Remember:** the sequence in the connector can be different depending on each product.
3. Once located the connector, start cabling the primary charger (the first of the chain). Use a UTP 5E cable (a pair), then, insert one of the cables in CAN-L and the other in CAN-H. After, connect the other chargers of the chain following the scheme below. As you may notice, all the chargers have CAN-L and a CAN-H inputs and outputs, except for the first and the last ones.

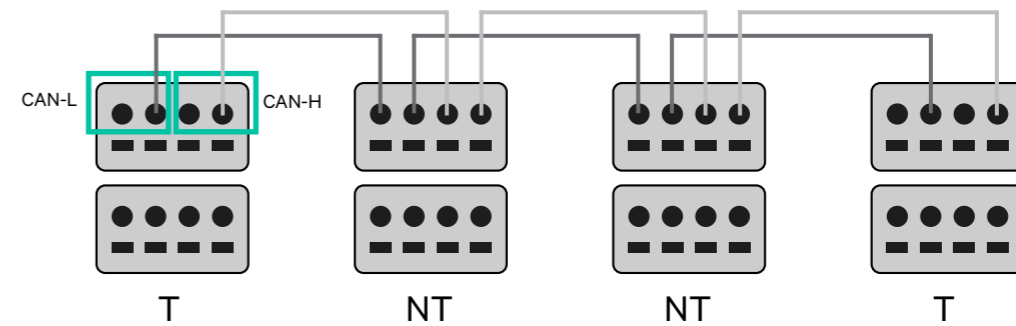

Important

- Make sure to connect each CAN-L to the respective CAN-L connector of all the chargers. Do the same for CAN-H.
- Static Load Management works up to 25 chargers for each installation. Among them, one is primary and 24 are secondary. The maximum distance the communication wiring can reach is 250m.

	CAN-L	CAN-H
CAN-L	✓	✗
CAN-H	✗	✓

Note: Only Max Current > 6A per phase is accepted for a correct performance. In case of doubts, contact Wallbox Service.

Dynamic Load Management (2+ Chargers)

Terminating settings

1. Once the cabling is complete, you need to activate the terminating resistors. First set up RS485 into T only for the charger that is connected into meter. Then set up the CAN BUS, the first and the last charger will always be terminating (T) with non terminating (NT) chargers between them.

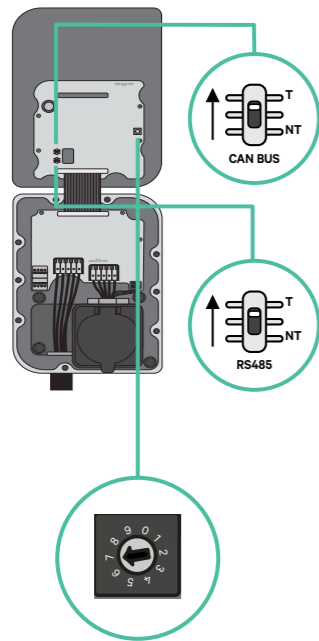
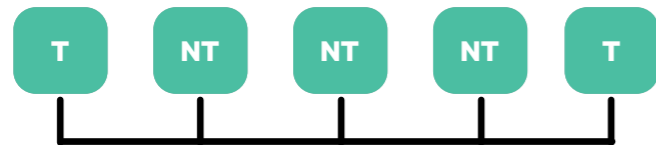

Dynamic Load Management (2+ Chargers)

2. Once the termination resistors are set up, place the current selector of each charger following the information. The first charger of the chain is the primary charger, the others are secondary.

The **primary charger** will be set on position 8 or 9.

The **secondary chargers** will be set on position 0.

POSITION	0	1	2	3	4	5	6	7	8	9
MAX CURRENT	*PS	6	10	13	16	20	25	32	*PS	*PS

3. To ensure a proper set-up the measured **resistance between CAN-H and CAN-L must be near to 60 Ohms**. If it differs from that, recheck the proper wiring and the T/NT configuration.

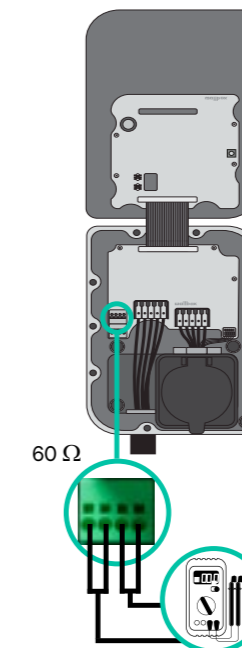

4. Close the cover of the charger following the instructions in the respective **Installation Guide**.

Dynamic Load Management (2+ Chargers)

Exemple of an installation with four chargers (CAN-Bus)

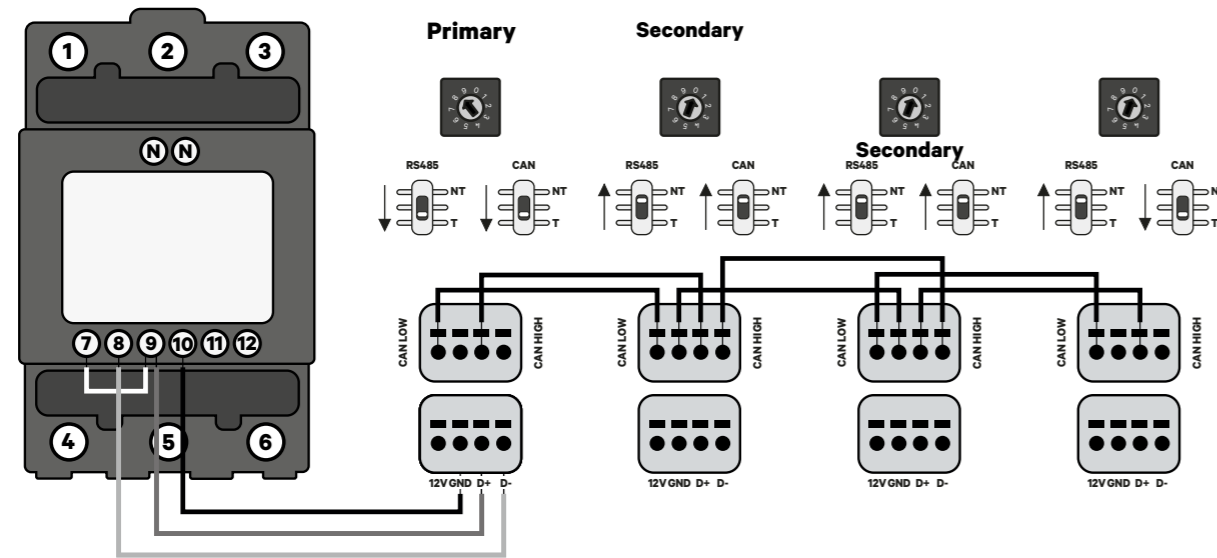

Adding chargers in the future:

If you anticipate adding chargers to the system in the future, there are two ways you can prepare the system now to make it ready for Dynamic Load Management (2+ Chargers).

Option 1: Place a bus disconnector to accommodate future chargers as shown in the option 1 wiring scheme below. This option avoids the need of reopening the existing chargers and hence it is the recommended option.

Option 2: Truncate the existing bus to add new charger(s) as shown in the option 2 wiring scheme below.

1. Open the charger following the installation guide of your Copper SB charger.
2. Set the terminating resistance into NT, make the communication wiring as explained above and then close the charger.



Important

New chargers may be placed anywhere physically in relation to the existing chargers as long as you follow these rules:

- You maintain the logic of the daisy chain.
- You respect the cabling polarity as described above under “Installation”.

Dynamic Load Management (2+ Chargers)

Wherever a future added charger is placed, the most important rule to follow is the logic of the daisy chain. For example, in the image below, the new charger is placed before the Terminating charger on the right side of the daisy chain.

Option 1:

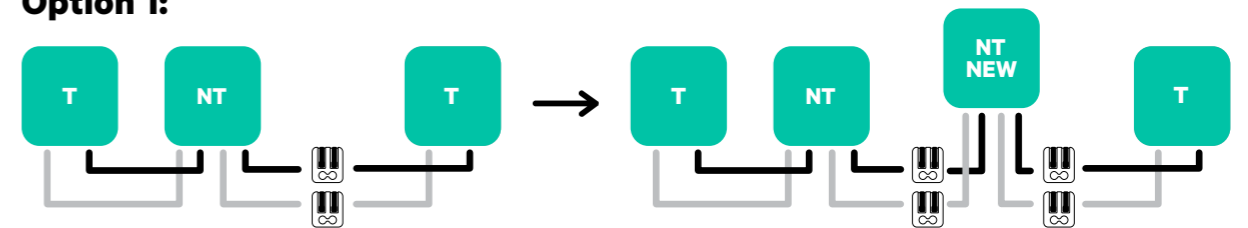

Option 2:

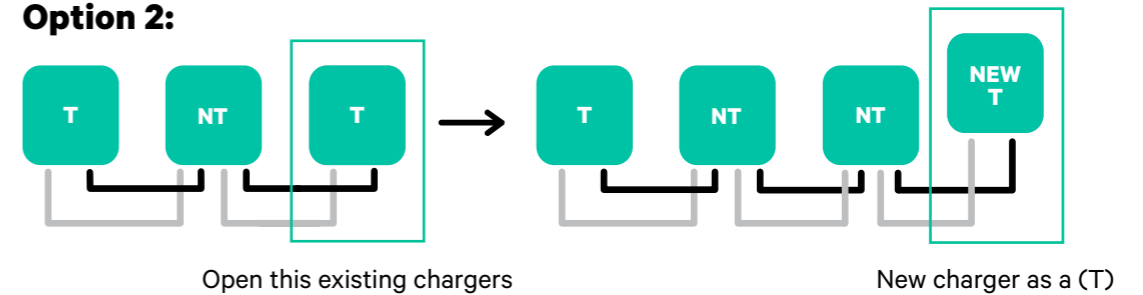

Once you finish the extension of the existing installation, continue with steps on the next page for setting up the chargers.

INSTALLATION WITH PULSAR MAX/PULSAR PRO

Getting started

General Characteristics

(Pulsar Max/Pulsar Pro)

	Static Load Management	Solar Charging	Dynamic Load Management (1 Chargers)	Dynamic Load Management (2+ Chargers)
Primary Chargers	1	1	1	1
Secondary Chargers	1-99	-	-	1-99
Communication protocol between the Primary Charger and the Energy Meter	-	Modbus RTU	Modbus RTU	Modbus RTU
Maximum total length between the first and the last charger of the chain	250m	-	-	250m
Maximum length between the wiring of the Primary charger and the Energy Meter	-	500m	500m	500m
Terminating Chargers	2	1	1	2
Maximum Phase Current configurable	-	-	Minimum between main switch rated (MCB) and the contract tariff	Minimum between main switch rated (MCB) and the contract tariff
Configurable installation maximum current	Installation main switch rated current (MCB)	-	-	Installation main switch rated current (MCB)
Wallbox App	Super admin or admin account	Super admin or admin account	Super admin or admin account	Super admin or admin account

Meters Compatibility Table

Meters	Dynamic Load Management (1 Charger)	Solar Charging	Dynamic Load Management (2+ Chargers)
EM340	✓	✓	✓
EM112	✓	✓	✓
SPM1-100-AC	✓	✗	✓
EM330 CTA 5X 250 A 5A	✓	✓	✓
EM330 CTA 6X 400 A 5A	✓	✓	✓
EM330 CTA 6X 600A 5A	✓	✓	✓
N1CT	✓	✓	✓
PRO2 MOD	✓	✓	✓
PRO380 MOD	✓	✓	✓

INSTALLATION WITH PULSAR MAX/PULSAR PRO

Dynamic Load Management and Solar Charging

Tools

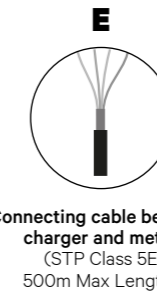
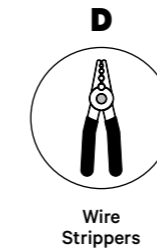
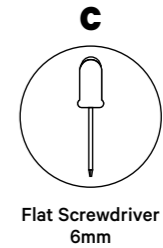
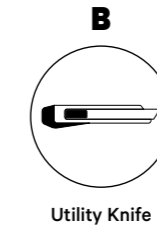
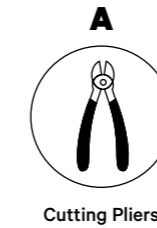

Refer to the [Pulsar Max Installation Guide](#) or the [Pulsar Pro Installation Guide](#) to know more about the tools required to install the charger.



Solar Charging cannot be used simultaneously with Static Load Management and Dynamic Load Management (2+ Chargers). However, it is fully compatible with Dynamic Load Management.

INSTALLATION WITH PULSAR MAX/PULSAR PRO Dynamic Load Management and Solar Charging

Place the energy meter after the fuse box (D) and the RCDs+MCDBs (G), just before the charger (I).

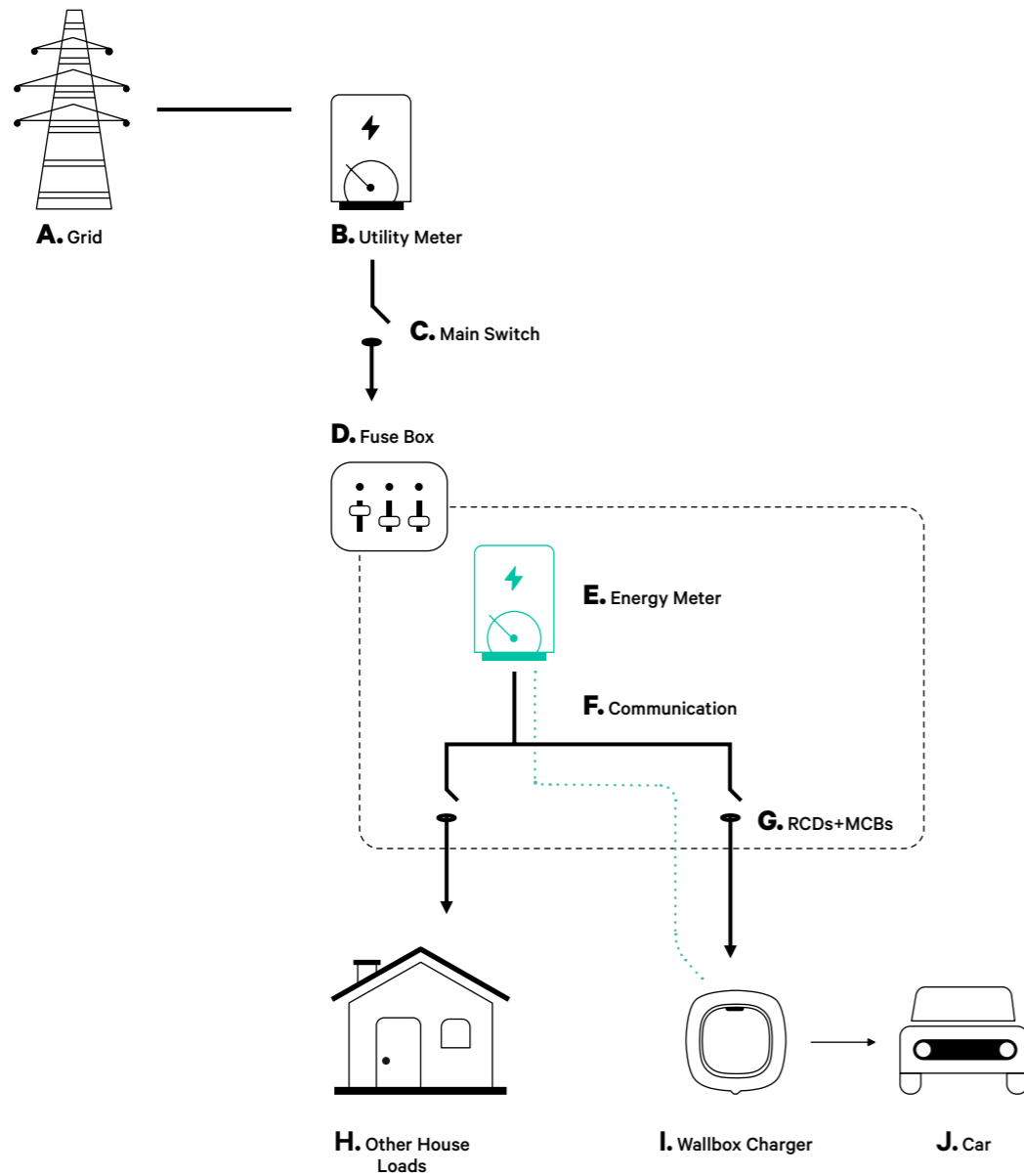

INSTALLATION WITH PULSAR MAX/PULSAR PRO Dynamic Load Management and Solar Charging

Before Installation

- Ensure that the power is turned off during the installation.
- Separate the communication wires from the power ones.

Preparation

1. Make a hole at the central grommet, using a small flat screwdriver.

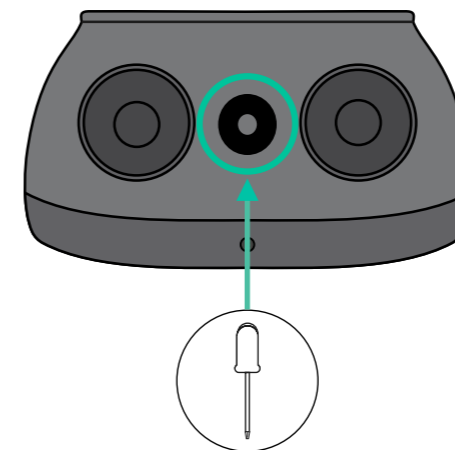

INSTALLATION WITH PULSAR MAX/PULSAR PRO Dynamic Load Management and Solar Charging

Pulsar Max Installation Guide

Install the charger following the instructions in the **Pulsar Max Installation Guide** or the **Pulsar Pro Installation Guide**.



Important

Ensure to not close the cover of the charger.

Communication wiring between the charger and the meter

1. Keep the power turned off during the installation.
2. Insert the communication wire through the grommet.

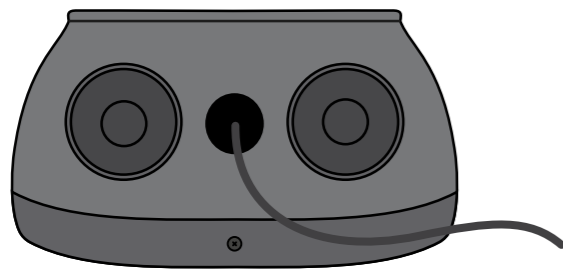

3. Install the meter following the instructions in the Meter Wiring Guide included in its package.
4. Wire the meter and the charger by following the relevant scheme below based on the model of your meter.



Important

It is mandatory to use an STP class 5E cable. Employ only 1 wire of each twisted pair and keep in mind that the communication wiring must not be more than 500m long.



Important

Insert only one cable in each grommet.

INSTALLATION WITH PULSAR MAX/PULSAR PRO Dynamic Load Management and Solar Charging

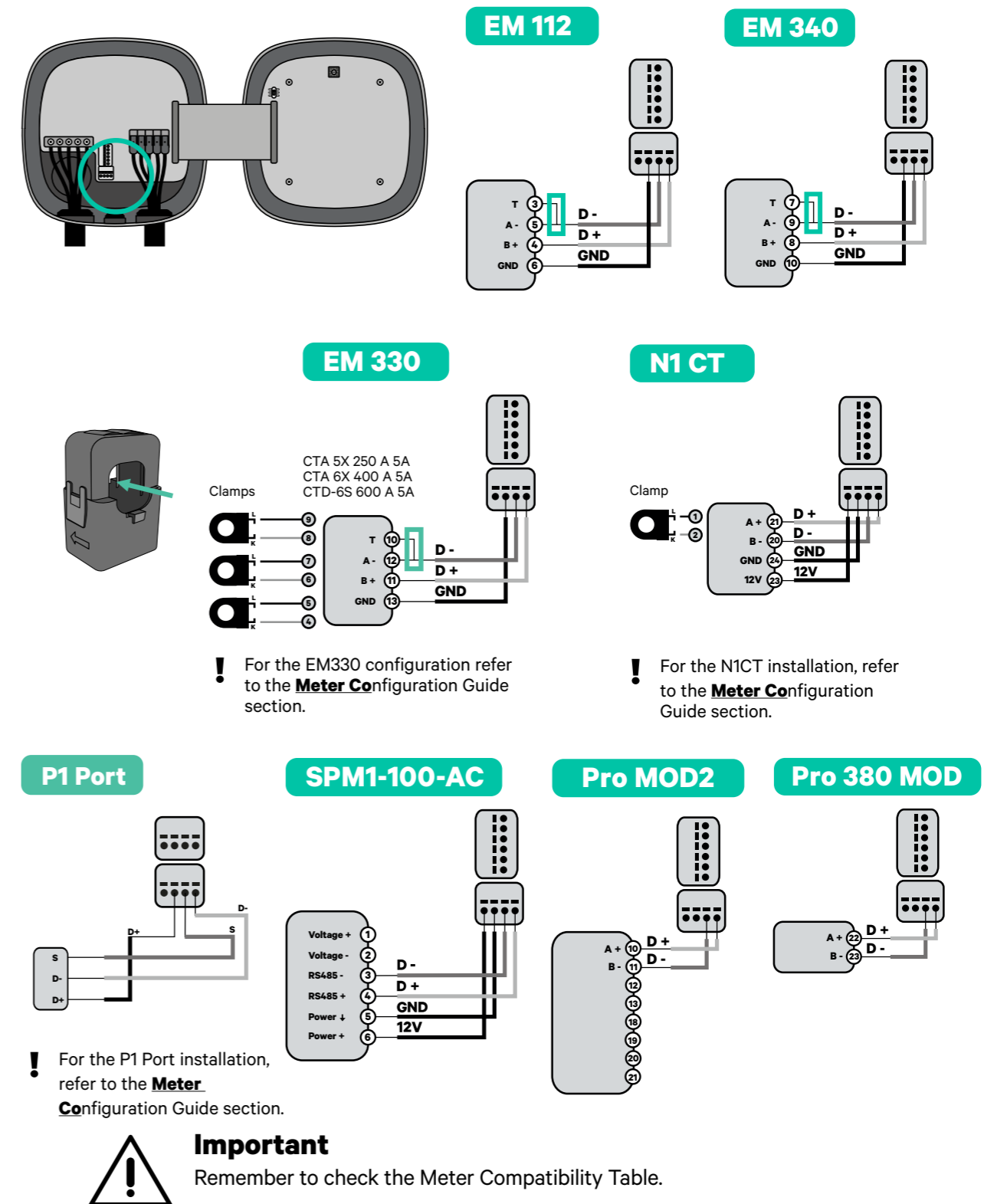

INSTALLATION WITH PULSAR MAX/PULSAR PRO

Dynamic Load Management and Solar Charging

Terminating resistance activation and current selector configuration

1. Put the Dynamic Load Management switch on the T position.
2. Put the rotary switch into a position between 1 and 7, depending on the maximum current that can be supplied from the charging network.

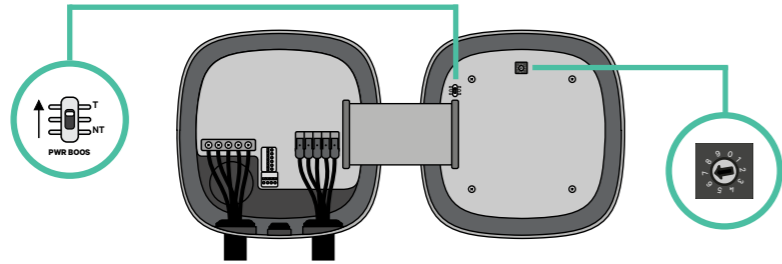

3. See the matrix below. This value must be equal or lower than the MCB protecting the Wallbox power line.

POSITION	0	1	2	3	4	5	6	7	8	9
CURRENT (A)	R	6	10	13	16	20	25	32	R	R

Note: Only Max Current > 6A per phase is accepted for a correct performance. In case of doubt, contact Wallbox Service.

4. Close the cover of the charger following the instructions in the chargers' Installation guides.
5. Once the installation is complete, do not forget to activate and finalise the Solar Charging and Dynamic Load Management configuration in the Wallbox App. You can follow [this guide to the process for Solar Charging](#) and [this one for Dynamic Load Management](#).

INSTALLATION WITH PULSAR MAX/PULSAR PRO

Static Load Management

Tools

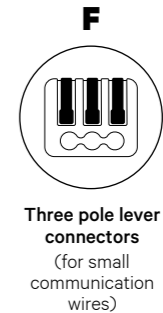
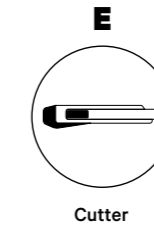
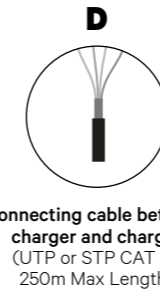
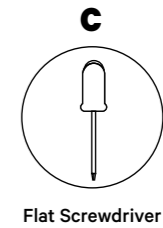
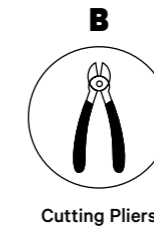
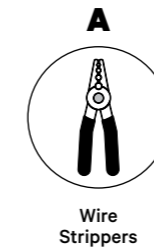

The installer has the responsibility to decide if the installation requires a UTP or STP 3rd wire to be used as a reference (GND).

Refer to the [Pulsar Max Installation Guide](#) or the [Pulsar Pro Installation Guide](#) to know more about the tools required to install the charger.



Important

Please note that Static Load Management cannot be used simultaneously with Solar Charging. Ensure you choose the most suitable power management option for your needs.

INSTALLATION WITH PULSAR MAX/PULSAR PRO Static Load Management



In order to use the Static Load Management function, **it must be used only between Pulsar Max and Pulsar Pro**, as they are compatible. Therefore they cannot be used with Static Load Management if they are paired with Pulsar Plus/Pulsar Plus Socket, Commander 2/2S and Copper SB.

Before Installation

- Ensure that the power is turned off during the installation.
- Separate the communication wires from the power ones.

Preparation

1. Make a hole at the central grommet, using a small flat screwdriver.

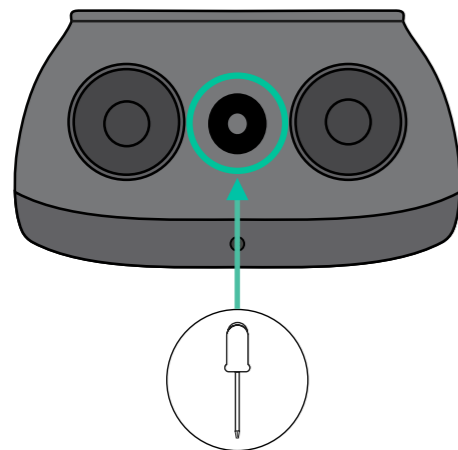

INSTALLATION WITH PULSAR MAX/PULSAR PRO Static Load Management

Wiring the system

1. Ensure that the power is turned off during the installation.
2. Insert the communication wire (UTP or STP 5E cable) through the grommet.

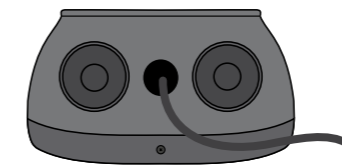

3. Check the position of the 6 pin connector.

Single Phase



Three phase

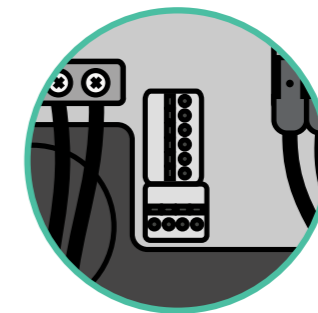

4. Once located the connector, start cabling the first charger of the chain. Check the Tools section to check if you need to use a third wire (GND).

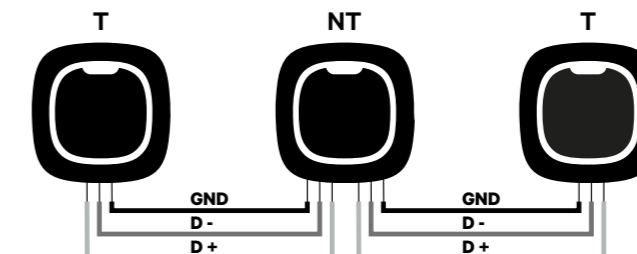

Important

- Static Load Management works up to 100 chargers for each installation. Among them, one is primary and 99 are secondary. The maximum distance the communication wiring can reach is 250m.

Note: Only Max Current > 6A per phase is accepted for a correct performance. In case of doubts, contact Wallbox Service.

Refer to the chargers' Installation guides for more information.

INSTALLATION WITH PULSAR MAX/PULSAR PRO Static Load Management

Terminating settings

1. Once the cabling is completed, you need to activate the termination resistors. The first and the last charger will always be terminating (T) with non terminating (NT) chargers between them.

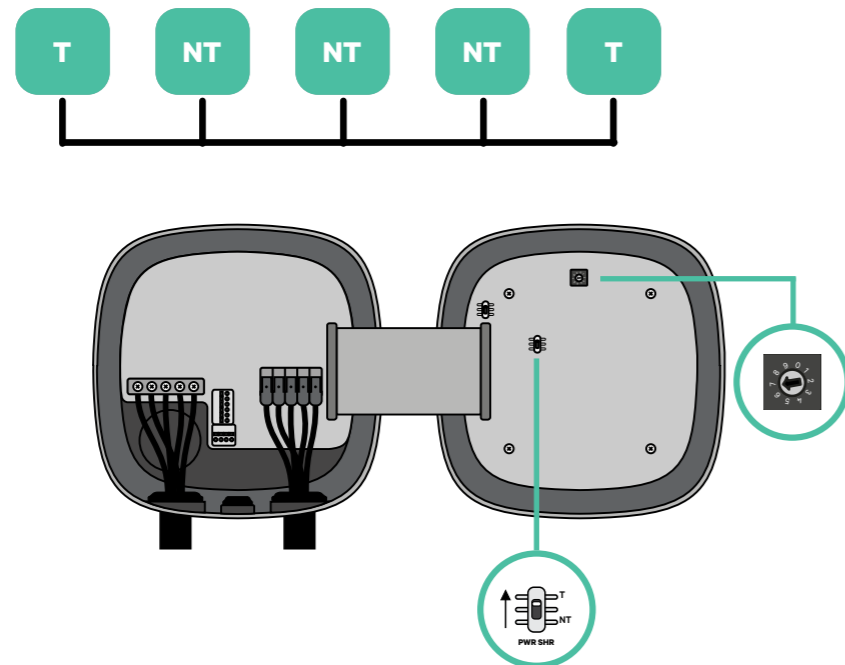

INSTALLATION WITH PULSAR MAX/PULSAR PRO Static Load Management

2. Once the termination resistors are set up, place the current selector of each charger following the information. Put the rotary switch into a position between 1 and 7 depending on the maximum current that can be supplied from the charging network.

POSITION	0	1	2	3	4	5	6	7	8	9
MAX CURRENT	R	6	10	13	16	20	25	32	R	R



Important

Make sure that the selector does not point to 0, 8 and 9.

3. Close the cover of your charger by following the instructions in the respective **Installation Guide**.
4. Once the installation is complete, do not forget to activate and finalise the Static Load Management configuration in the Wallbox App. You can follow **this guide** to the process.

INSTALLATION WITH PULSAR MAX/PULSAR PRO

Static Load Management

Adding chargers in the future:

If you anticipate adding chargers to the system in the future, there are two ways you can prepare the system now to make it ready for Static Load Management.

Option 1: Place a bus disconnecter to accommodate future chargers as shown in the option 1 wiring scheme below. This option avoids the need for reopening the existing chargers and hence is the recommended option.

Option 2: Truncate the existing bus to add new charger(s) as shown in the option 2 wiring scheme below:

1. Open the charger following the installation guide of your Pulsar Max/Pulsar Pro charger.
2. Set the Static Load Management terminating resistor to NT, establish the communication wiring as explained above and close the charger.



Important

New chargers may be placed anywhere physically in relation to the existing chargers as long as you follow these rules:

- You maintain the logic of the daisy chain.
- You respect the cabling polarity as described above under “Installation”.

Wherever a future added charger is placed, the most important rule to follow is the logic of the daisy chain. For example, in the image below, the new charger is placed before the Terminating charger on the right side of the daisy chain.

Option 1:

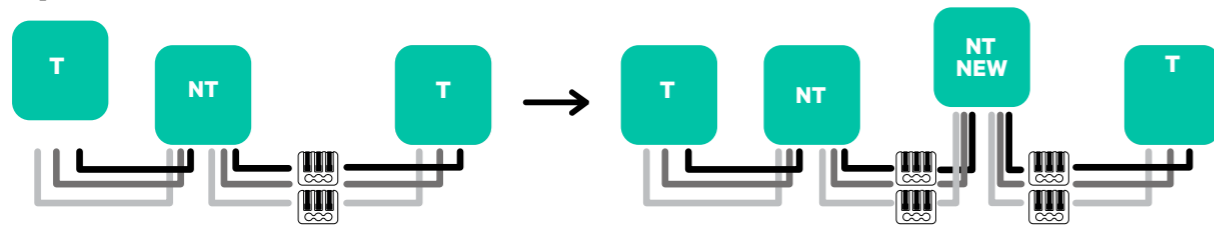

Option 2:

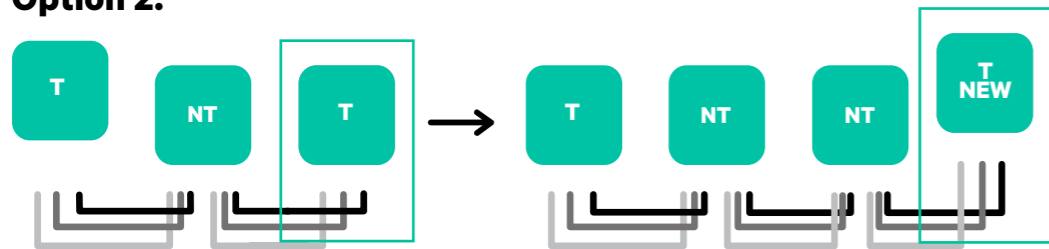

Open this existing chargers

INSTALLATION WITH PULSAR MAX/PULSAR PRO

Dynamic Load Management (2+ Chargers)

Tools

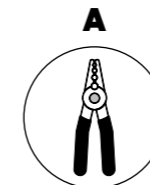

Wire Strippers

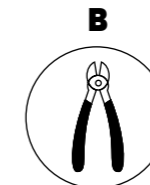

Cutting Pliers

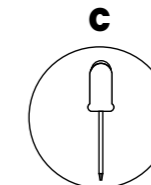

Flat Screwdriver

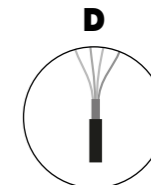

Connecting cable between charger and meter (STP Class 5E 500m Max Length)

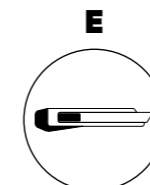

Cutter

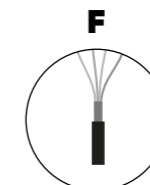

Connecting cable between charger and charger (UTP or STP CAT 5E 250m Max Length)

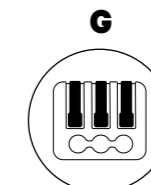

Three pole lever connectors (for small communication wires)



The installer has the responsibility to decide if the installation requires a UTP or STP 3rd wire to be used as a reference (GND).

Refer to the **Pulsar Max Installation Guide** or the **Pulsar Pro Installation Guide** to know more about the tools required to install the charger.



Important

Please note that **Dynamic Load Management (2+ Chargers) cannot be used simultaneously with Solar Charging**. Ensure you choose the most suitable power management option for your needs.

INSTALLATION WITH PULSAR MAX/PULSAR PRO Dynamic Load Management (2+ Chargers)



Pulsar Pro and Pulsar Max are compatible, but aren't compatible with Pulsar Plus/Pulsar Plus Socket, Commander 2/2S and Copper SB, so Dynamic Load Management (2+ Chargers) should be used only between Pulsar Max and Pulsar Pro.

Before Installation

- Ensure that the power is turned off during the installation.
- Separate the communication wires from the power ones.

Preparation

1. Make a hole in the central grommet, using a small flat screwdriver.

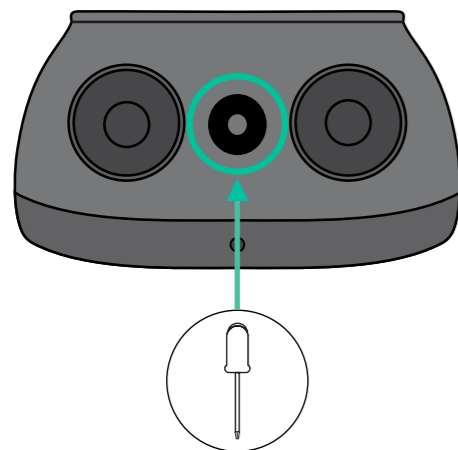

INSTALLATION WITH PULSAR MAX/PULSAR PRO Dynamic Load Management (2+ Chargers)

Pulsar Max/Pulsar Pro Installation Guide

Install the charger as detailed in the [Pulsar Max Installation Guide](#) or the [Pulsar Pro Installation Guide](#).



Important

Ensure not to close the cover of the charger.

Communication wiring between the charger and the meter

1. Keep the power turned off during the installation.
2. Insert through the grommet the two communication wires, one for meter communication and the other one for communication between chargers.

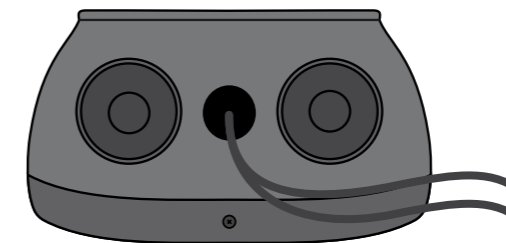

3. Install the meter following the instructions in the Meter Wiring Guide included in the package.
4. Wire the meter and the charger by following the relevant scheme below based on the model of your meter.



Important

For the communication with the meter it is mandatory to use STP class 5E cable and remember the communication wiring must not be longer than 500 meters.



Important

For the communication between chargers it is mandatory to use UTP or STP class and remember that all the chargers chain must not be longer than 250 meters.

INSTALLATION WITH PULSAR MAX/PULSAR PRO Dynamic Load Management (2+ Chargers)

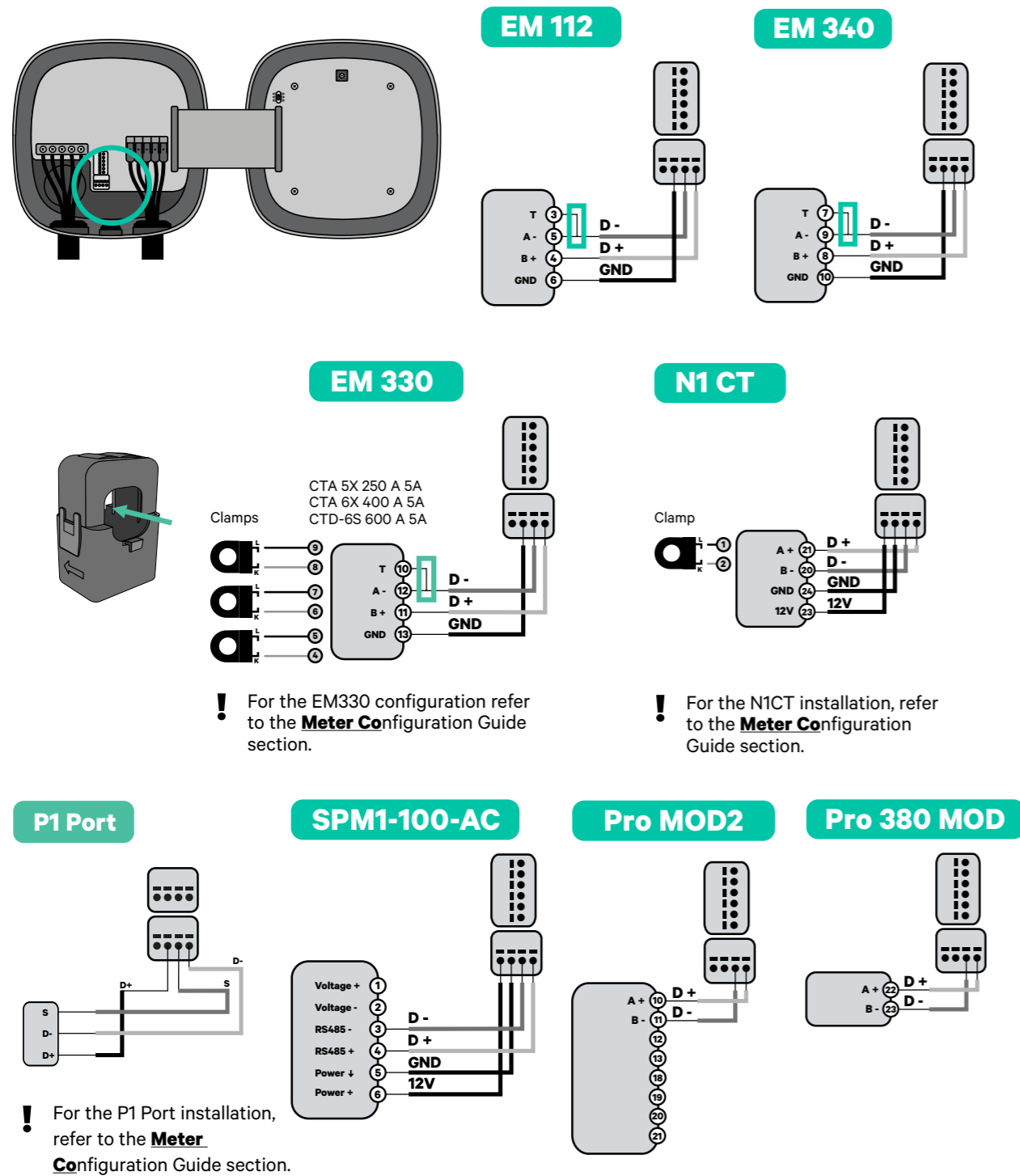

Important
Remember to check the **Meter Compatibility Table**.

INSTALLATION WITH PULSAR MAX/PULSAR PRO Dynamic Load Management (2+ Chargers)

Wiring the system

1. Ensure that the power is turned off during the installation.
2. Check the position of the 6 pin connector.

Single Phase



Three phase

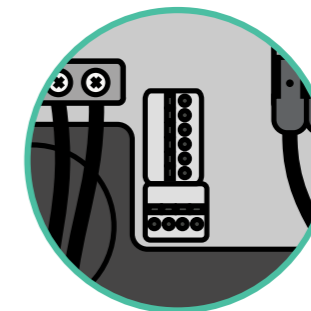

4. Once located the connector, start cabling the the first charger of the chain. Check the Tools section to check if you need to use a third cable (GND).

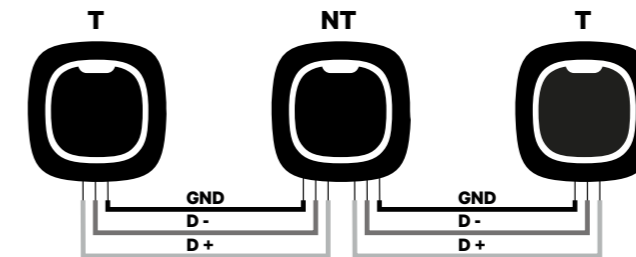

Important

- Dynamic Load Management (2+ Chargers) works up to 100 chargers for each installation. Among them, one is primary and 99 are secondary. The maximum distance the communication wiring can reach is 250m.

Note: Only Max Current > 6A per phase is accepted for a correct performance. In case of doubts, contact Wallbox Service.

Refer to the **Pulsar Max Installation Guide** or the **Pulsar Pro Installation Guide** for more information.

INSTALLATION WITH PULSAR MAX/PULSAR PRO Dynamic Load Management (2+ Chargers)

Terminating settings

- Once the cabling is complete, you need to activate the terminating resistors. First set up Dynamic Load Management into T only for the charger that is connected into meter. Then, set up Static Load Management, the first and the last charger will always be terminating (T) with non terminating (NT) chargers between them.

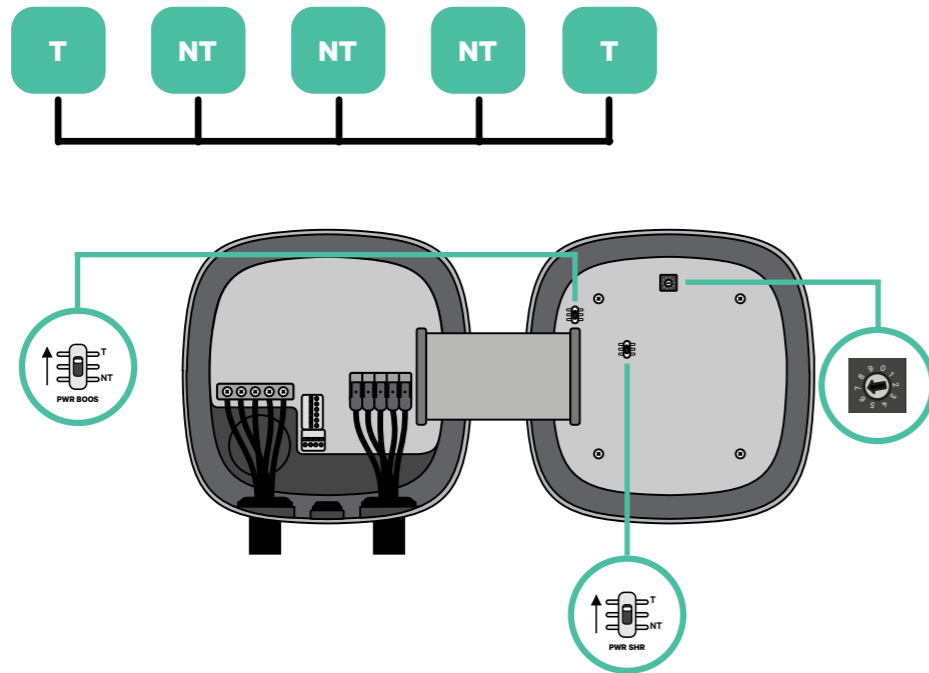

Important

Only for Pulsar Max Rev A with a Temco clamp, set up the Dynamic Load Management into NT.

INSTALLATION WITH PULSAR MAX/PULSAR PRO Dynamic Load Management (2+ Chargers)

- Once the termination resistors are set up, place the current selector of each charger following the information. Put the rotary switch into a position between 1 and 7 depending on the maximum current that can be supplied from the charging network.

POSITION	0	1	2	3	4	5	6	7	8	9
MAX CURRENT	R	6	10	13	16	20	25	32	R	R



Important

Make sure that the selector does not point to 0, 8 and 9.

- Close the cover of your charger by following the instructions in the respective **Installation Guide**.
- Once the installation is complete, do not forget to activate and finalise the Dynamic Load Management (2+ Chargers) configuration in the Wallbox App.

Exemple of an installation with four chargers (Daisy Chain)

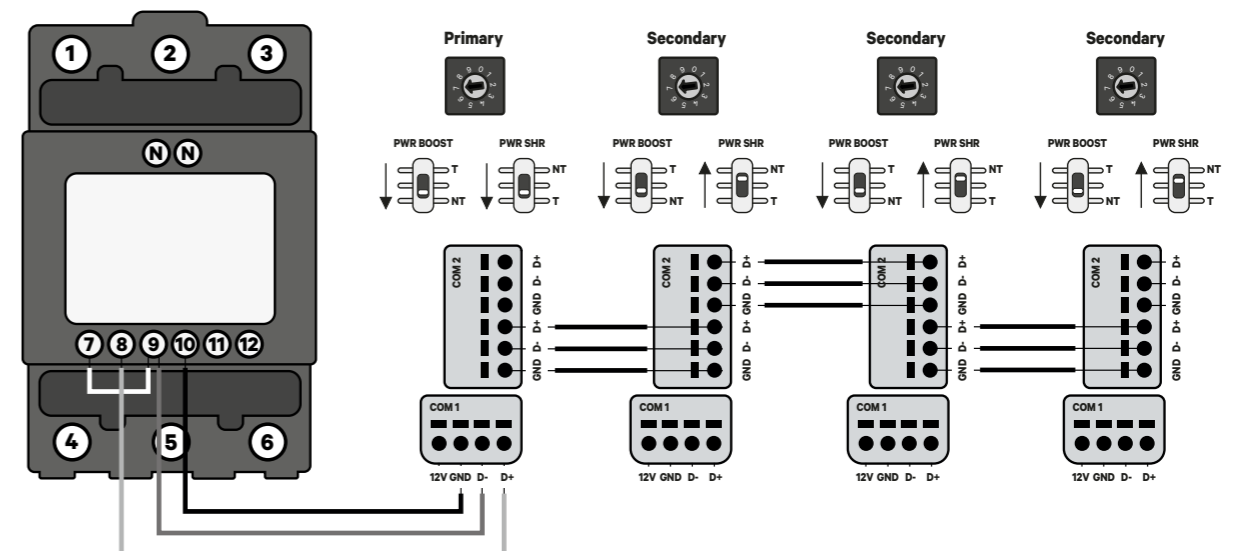

INSTALLATION WITH PULSAR MAX/PULSAR PRO

Dynamic Load Management (2+ Chargers)

Adding chargers in the future:

If you anticipate adding chargers to the system in the future, there are two ways you can prepare the system now to make it ready for Dynamic Load Management (2+ Chargers).

Option 1: Place a bus disconnecter to accommodate future chargers as shown in the option 1 wiring scheme below. This option avoids the need of reopening the existing chargers and hence it is the recommended option.

Option 2: Truncate the existing bus to add new charger(s) as shown in the option 2 wiring scheme below.

1. Open the charger following the installation guide of your Pulsar Max/Pulsar Pro charger.
2. Set the terminating resistor Static Load Management into NT, make the communication wiring as explained above and then close the charger.



Important

New chargers may be placed anywhere physically in relation to the existing chargers as long as you follow these rules:

- You maintain the logic of the daisy chain.
- You respect the cabling polarity as described above under “Installation”.

Wherever a future added charger is placed, the most important rule to follow is the logic of the daisy chain. For example, in the image below, the new charger is placed before the Terminating charger on the right side of the daisy chain.

Option 1:

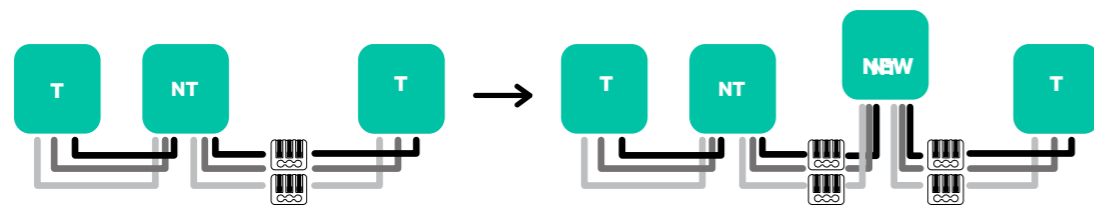

Option 2:

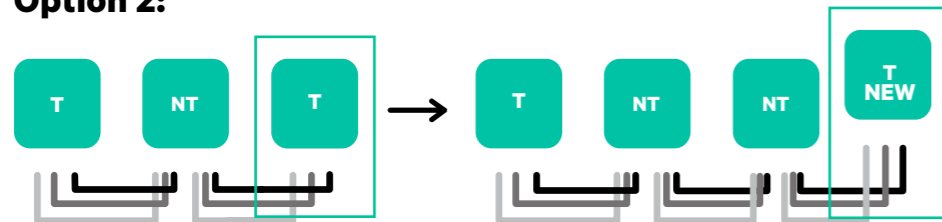

Open this existing chargers

Note: Check the terminating settings on page 83 to know when to set T or NT on the first and last charger of the installation.

EMS Configuration and Troubleshooting

CONFIGURATION

Static Load Management



Important

Static Load Management cannot be used simultaneously with Solar Charging.

1. Enabling Static Load Management

Follow these steps to activate Static Load Management once you have installed your charger correctly:

Step 1: Connect your App to your charger

- 1.** Before you begin, ensure your Wallbox charger and Wallbox app run the latest versions.
- 2.** Open the Wallbox app and log in using your credentials. You can easily register within the app if you don't have an account yet.
- 3.** Select your charger and ensure your smartphone remains within Bluetooth range throughout the configuration process. Follow these instructions if your charger isn't linked to your Wallbox account.
- 4.** If it's the first time you're connecting your charger to the Wallbox app, establish a Bluetooth connection. If you've already done this, wait until the Bluetooth connection is established.

Step 2: Setting up Static Load Management

- 5.** Once your charger and Wallbox app are connected, navigate to Settings.
- 6.** Tap on "Load Management" under Energy features.

Step 3: Customise Settings

- 7.** Specify the number of chargers in your installation (including the Primary charger).
- 8.** In the "Max. current per phase for the charger's network", enter the main breaker-rated current or subscribed current (in amps), selecting the lower value.

CONFIGURATION

Static Load Management

- 9.** Define the Min. current per charger (in amps) for each charger.

- 10.** Tap Save to enable SLM.

2. Status Messages

Status text	Shown in	Description
"Installation configuration error. The entered number of chargers does not match the number detected in the installation."	Settings	Only on the Primary unit. The network has been successfully set up. Some Secondary units are not connected. Verify that the setting "number of chargers" in the Primary unit coincides with the number of chargers in the system. Verify wiring.
"Static Load Management not configured"	Charger Screen	This is the initial status after powering on the set-up. The unit is paired with the Primary unit, but it detects that it is pending to be configured. The chargers will blink in red.
"Configuration required"	Settings	This is the initial status after powering on the set-up. The unit is paired with the Primary unit, but it detects that it is pending to be configured. The chargers will blink in red.
"Secondary charger. To modify Load Management configuration please go to the Primary charger."	Settings	Secondary connected with the Primary. The installation has been successful. Use the Primary charger to adjust the settings.
"Secondary charger not paired with network"	Settings	The secondary is not successfully connected with the primary on the Static Load Management network. This state is reached after 30 seconds without successful communication. In this state, the charger will have a fast-blinking Halo. Remember that the secondary can only charge at 6 A in this state.

CONFIGURATION

Static Load Management

Status text	Shown in	Description
“Waiting for energy. Load Management will resume charging”	Charger Screen	<p>There is not enough power available for this charger.</p> <p>If the power has already been reduced to the minimum, the newly plugged cars will enter this state.</p> <p>Once the system has enough power available (e.g. a car has been fully charged), it will start charging. The charger will be slowly blinking.</p>

CONFIGURATION

Dynamic Load Management (2+ Chargers)



Important

Dynamic Load Management (2+ Chargers) cannot be used simultaneously with Solar Charging. However, it is fully compatible with all the other EMS.

Enabling Dynamic Load Management (2+ Chargers)

Follow these steps to activate Dynamic Load Management once you have installed your charger and its compatible energy meter:

Step 1: Connect your App to your charger

- 1.** Before you begin, ensure your Wallbox charger and Wallbox app run the latest versions.
- 2.** Open the Wallbox app and log in using your credentials. You can easily register within the app if you don't have an account yet.
- 3.** Select your charger and ensure your smartphone remains within Bluetooth range throughout the configuration process.

Step 2: Setting up Dynamic Load Management

- 4.** Tap the “Settings” cogwheel icon in the top-right screen's corner.
- 5.** Tap on “Load Management” under Energy features.
- 6.** Specify the number of chargers in your installation (including the Primary charger).
- 7.** In the “Max. current per phase” field, enter the max current per phase for the charger's network.
- 8.** Define the “Building max. current per phase” corresponding to the maximum current per phase for both the DLM network and the building, selecting the lower value between the subscribed current and the MCB. For correct performance, only max current per phase greater than 6 amps is accepted.
- 9.** Define the “Minimum current per charger” (in amps) for each charger to operate.
- 10.** Turn on the switch button and tap “Save” to enable DLM.

CONFIGURATION

Dynamic Load Management (1 charger)

Enabling Dynamic Load Management in Single-charger Installations

Follow these steps to activate Dynamic Load Management once you have installed your charger and its compatible energy meter:

Step 1: Connect your App to your charger

- 1.** Before you begin, ensure your Wallbox charger and Wallbox app run the latest versions.
- 2.** Open the Wallbox app and log in using your credentials. You can easily register within the app if you don't have an account yet.
- 3.** Select your charger and ensure your smartphone remains within Bluetooth range throughout the configuration process.

Step 2: Setting up Dynamic Load Management

- 4.** Once the synchronization between your charger and your app is complete, go to Settings.
- 5.** Tap Load Management under Energy Features.
- 6.** Enable the DLM feature by switching the button to the ON position.
- 7.** In the "Max. current per phase" field, specify the main breaker-rated current or subscribed current (in amps), whichever is lower. Only max current per phase greater than 6 amps is accepted.
- 8.** Tap Save to enable DLM.

CONFIGURATION

Solar Charging



Important

Solar Charging cannot be used simultaneously with Static Load Management and Dynamic Load Management (2+ Chargers). However, it is fully compatible with Dynamic Load Management.

Enabling Solar Charging

Follow these steps to activate Solar Charging once you have installed your charger and its compatible energy meter:

Configure the inverter mode: Your installer must set your energy generation system's inverter mode to "Export" to enable the export of surplus green energy to the grid.

Step 1: Connect your App to your charger

- 1.** Before you begin, ensure your Wallbox charger and Wallbox app run the latest versions.
- 2.** Open the Wallbox app and log in using your credentials. You can easily register within the app if you don't have an account yet.
- 3.** Select your charger and wait until the connection is established. If your charger is not connected to the Internet, please ensure your smartphone remains within Bluetooth range throughout the configuration process.

Step 2: Setting up Solar Charging

- 4.** Tap the "Settings" cogwheel icon in the top-right screen's corner.
- 5.** Tap "Solar Charging" under "Energy Features".
- 6.** Switch the toggle button on, and choose between the two charging modes:
- 7.** Tap "Save" to activate Solar Charging.

CONFIGURATION

Solar Charging

Eco mode: Minimize the use of grid power while charging your EV by combining it with any surplus green energy available. Eco mode detects the green energy not used elsewhere in your home in real-time and mixes it with energy from the grid to ensure an efficient charge.

Full green mode: Use exclusively green energy to charge your car. The Full green mode will detect when surplus green energy is available at your home to meet the minimum requirements to power your vehicle. Your car will begin charging, meaning every charge is fully green.

4. Charging Conditions

4.1. Charging Conditions in Single-Phase Installations

Solar Charging initiates charging your EV once it fulfils specific conditions. These conditions vary based on your installation type and the Solar Charging mode you've selected:

- Eco mode: Eco mode starts a charge with a minimum surplus of 2A (approx. 460W). The grid then complements this surplus for the charge session to begin. The grid will only be utilised while the charge starts, so a maximum of 4A will be used.
- Full green mode: With Full green mode, the charge starts only if the surplus is equal to or greater than 6A (approx. 1380W), as this is the lowest charging current at which a vehicle can charge.

4.2. Charging Conditions in Three-Phase Installations

Solar Charging checks the total active power, L1+L2+L3. If the sum of all the phases exceeds the required power, the system will start charging, regardless of whether it is balanced. This ensures that the surplus of energy is used.

- Eco mode: The power needed is 2A per phase, or 6A (total sum of L1+L2+L3).
- Full green mode: In Full green mode, the charge starts if the surpluses are equal to or greater than 3x6A (approx. 4140W), as this is the lowest charging current of a three-phase vehicle.

CONFIGURATION

Solar Charging

5. Disclaimers

- Schedules and manual actions take priority over the Solar Charging functionality. When charging manually or on schedule, your charger will still use the available surplus and top it up with grid power for faster charging.
- Solar Charging might discharge your BESS (Battery Energy Storage System).
- The Solar Charging functionality is not available for Renault ZE Ready vehicles.
- The Inepro meters (sold only by Wallbox) will work with Solar Charging since a Modbus modification has made them compatible.
- Please be aware that having OCPP and Solar Charging enabled might result in some incompatibilities.

CONFIGURATION

Troubleshooting

1. Basic Troubleshooting

If you have a compatible meter installed correctly but are still having trouble activating an EMS using an energy meter, it could be due to your charger not detecting the energy meter. Before going through advanced steps:

1. Ensure you have a compatible energy meter installed correctly.
2. Check if the energy meter is powered on.
3. Power off and then on your charger. Sometimes, the charger may not recognize the energy meter if powered on after the charger.
4. Verify if your charger's software is up to date.
5. Close the Wallbox app, reopen it, and disconnect and reconnect the charger via Bluetooth.
6. For EM340, EM112 or EM330 energy meters, ensure that the 'Rx' and 'Tx' icons are blinking in the bottom right corner of the energy meter screen. If not, try restarting the charger again, as it may not communicate with the meter.

2. Advanced Troubleshooting

If the previous steps haven't resolved the issue, you can perform the following checks:

1. Ensure the wiring between the charger and the energy meter is correct, including proper connections and continuity. Make sure to use the appropriate cable type (Cat5e).
2. Power off both the charger and the energy meter, then measure the resistance between D+ and D- (or B+ and A- on the energy meter). It should measure around 60 Ohms.
3. Check that the RS485 switch is in position T and the rotary switch is set

Meters Configuration Guide

EM333 Configuration

EM330 Configuration (applicable to every EMS)

1. Press the button in the middle for 1.5 seconds to enter the password confirmation screen.

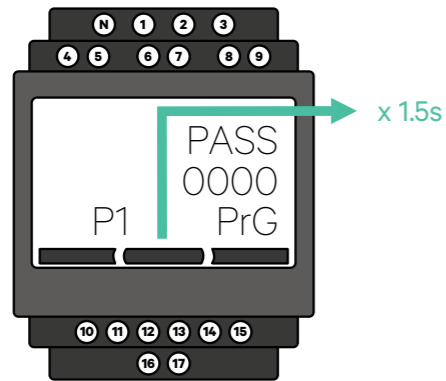

2. The pre-defined password is 0000. Just press the left and the right button at the same time to confirm.

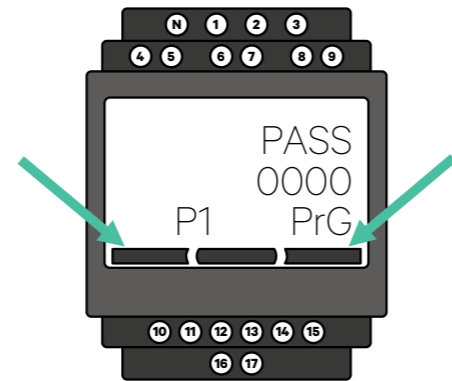

3. Using the right and left buttons, scroll up to the "Ct rAt lo" item. Press the middle button for 1.5 second and modify the value using the left and right buttons. Press the middle button to confirm the value.

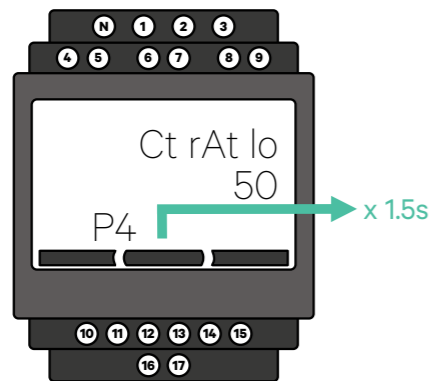

4. **FOR Solar Charging ONLY:** Access the "MEASURE" menu. Hold down the middle button for 1.5 seconds to adjust values using the left and right buttons. Change the default "A" value to "B," then press the middle button to confirm.

5. Scroll down to the "end" option and press enter to exit the programming menu.

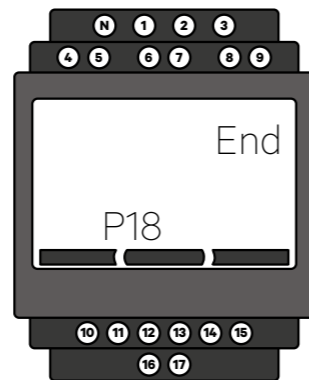

How to install N1 CT

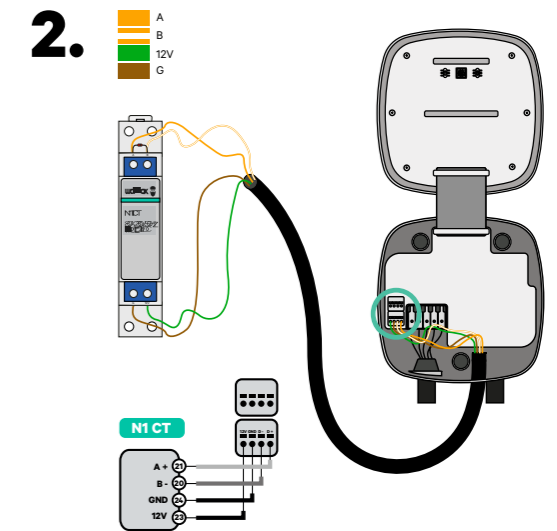
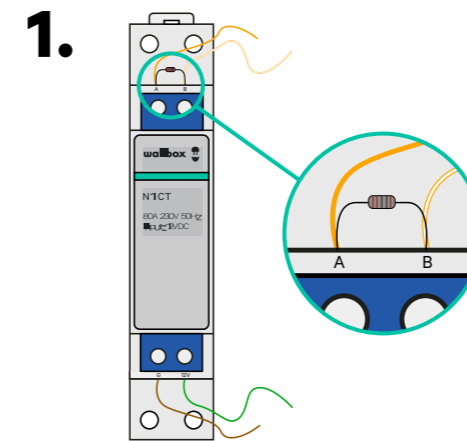

Important

Communication end resistor: the 120 Ohms resistor included is to be added between the A-B connectors of the meter.

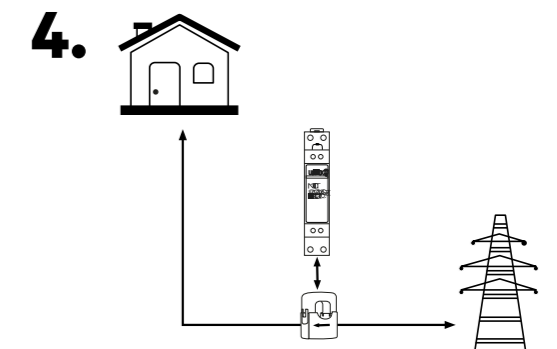
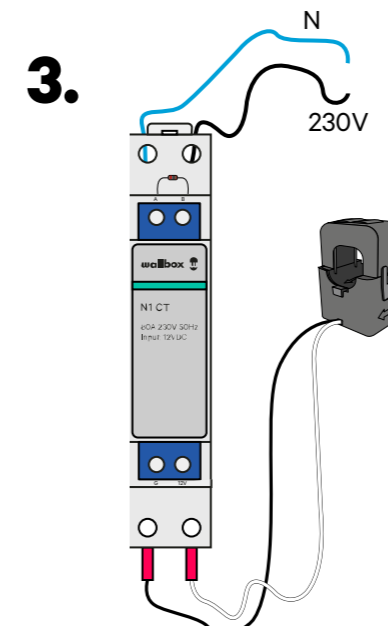

Disclaimer

The connection of the 230V AC wires is only needed when Solar Charging is activated. This connection is not needed for activating Dynamic Load Management.

INSTALLATION WITH PULSAR PLUS/PULSAR PLUS SOCKET,
COMMANDER 2/2S, COPPER SB, PULSAR MAX/PULSAR PRO

How to install P1 Port

1. Depending on the country, the P1 port can be already activated or not. Contact the utility company to check the status and proceed with the activation when needed.

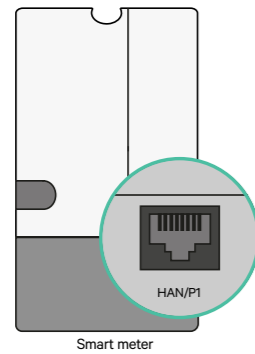

2. Fix the P1 Port meter to the DIN rail. Then, connect the RJ12 connector to the utility meter and the Wallbox P1 metering solution.

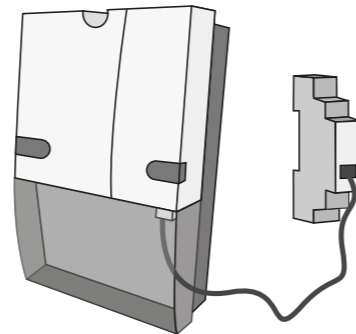

3. Look at the diagram to check how to wire P1 Port to a charger.

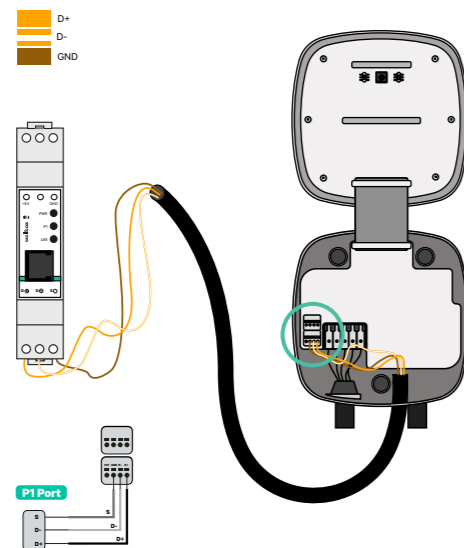

Disclaimer

The P1MB is connected via an RJ12 connection to the P1 Port. The device is powered by the +5V of the P1 Port of the connected smart meter. If not available, the P1MB can optionally be powered by an external adapter connected to the DC power interface.

INSTALLATION WITH PULSAR PLUS/PULSAR PLUS SOCKET,
COMMANDER 2/2S, COPPER SB, PULSAR MAX/PULSAR PRO

How to install P1 Port

4. Once the installation is completed and the charger is configured, check the P1 Port's led lights:

Power Status Led - Yellow

If the yellow light is on, the P1 Port is powered, while the device is not powered, in case the led is off.

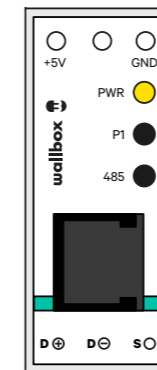

P1 Status Led - Green

If the green light is on, P1 data was received with the correct CRC. If it is off, no P1 data was received from the smart meter within the last minute.

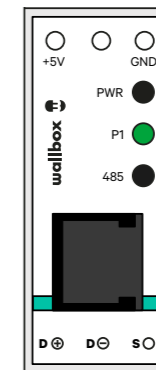

Modbus Status LED - Red

If the red light is on, a valid Modbus request was received within the last minute. If it is blinking, some data was received, but no valid Modbus request was received. If it is off, no data was received in the past 6 minutes.

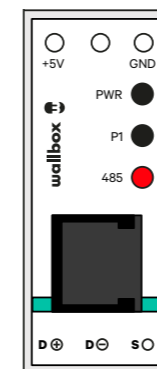



support.wallbox.com