

ENERGY METERS

Installation Guide

wallbox ™

Purpose and Scope of the Document:

The purpose of this document is to outline the instructions for installation of energy meters compatible with the Power Boost and Eco-Smart functionalities.

For instructions to install an MID meter, refer to the relevant **Installation Guide**.

Important Notes

- 1.** After the installation, connect the energy meter before closing your charger. In case the charger had already been installed, open it to connect the energy meter.
- 2.** Only energy meters delivered by Wallbox are compatible.
- 3.** The installation must be performed only by suitably qualified personnel, according to local regulations.

Important Notes

- 4.** Make sure to update your charger with the latest software version before installing the meter.
- 5.** Ensure the charger is powered off before connecting the meter.
- 6.** For more information, refer to your charger's **Installation Guide** on Wallbox Academy.

Materials and Tools

Inside the Box



Meter



Meter Wiring Guide



Grommet



Dynamic Power Sharing Installation Manual

Devices



Pulsar Plus



Commander 2



Copper SB

Materials and Tools

Tools

A



**Philips
Screwdriver**

B



Cutting Pliers

C



Torx T9
Pulsar Plus
Commander 2

D



Torx T20
Copper SB

E



**Wire
Strippers**

F

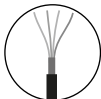

**Recommended
Cable**
(STP Class 5E
500 Max Length)

Compatibility Table

Meters	Power Boost	Eco-Smart
EM340	PF.A / PF.B	PF.B
EM112	PF.A / PF.B	PF.B
SPM1-100-AC	✓	✗
EM330 CTA 5X 250 A 5A CTA 6X 400 A 5A CTD-6S 600 5A	✓	✓
N1CT	✓	✓
PRO2 MOD	✓	✓
PRO380 MOD	✓	✓

Placement

1. Place the energy meter after the mains supply in the fuse box.

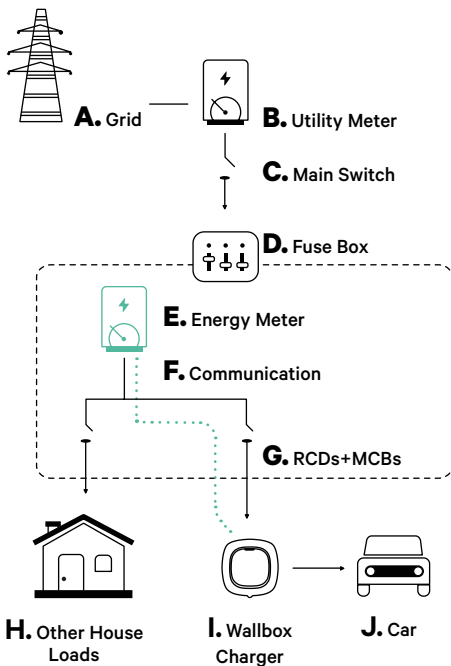

Placement

- 2.** For all the meters, follow the corresponding manual included in the box.

EM 340*



EM 112



EM 330

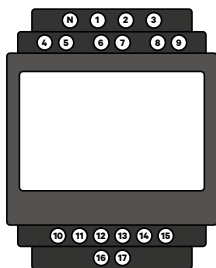

- A.** 3-Phase < 65 A **B.** 1-Phase < 100 A **C.** 3-Phase < 250 A

Note: For the EM340 and the EM112 meters, only the PF.B versions are compatible with the Eco-Smart functionality.

For the Power Boost functionality, both the PF.A and PF.B versions of EM340 and EM112 meters are compatible.

Refer the Eco-smart configuration article to know more.

SPM1-100-AC*

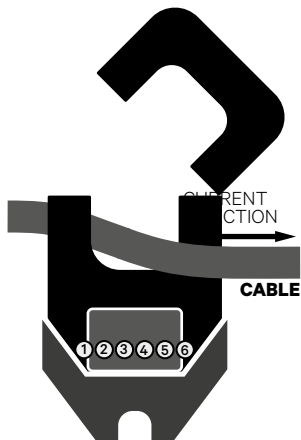

- 1.** Used for 1-Phase installation. Up to **100A**.
- 2.** Clip the power meter to the mains power cable.
- 3.** Neutral cable must not be drawn through the clamp.

Note: Ensure to insert the cable through the clamp in the correct direction as shown.

*Not compatible with the Eco-Smart functionality.

Pro MOD2 / Pro 380 MOD / N1 CT

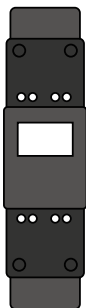

A. 1-Phase < 100A

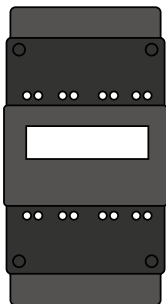

B. 3-Phase < 65A

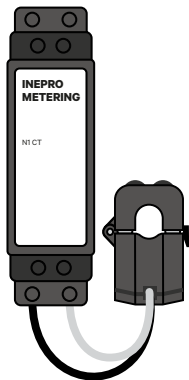

C. 1 - Phase < 80A

Pulsar Plus

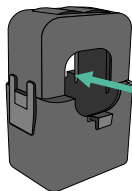
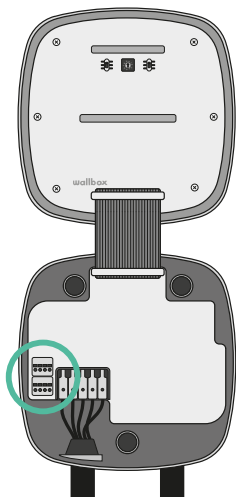

Current
Direction

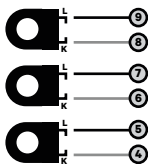

EM 112

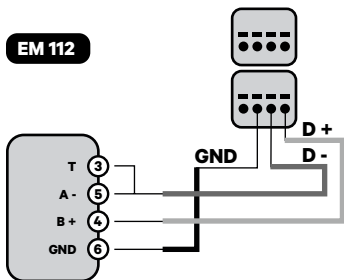

EM 340

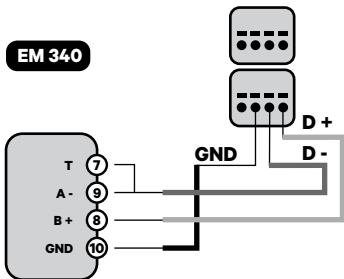

EM 330

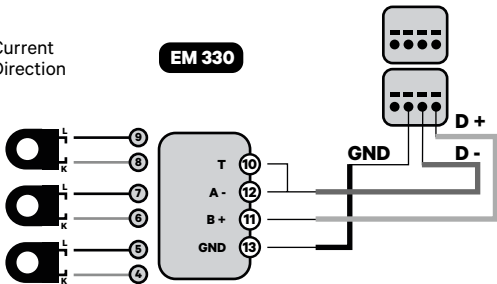

N1 CT

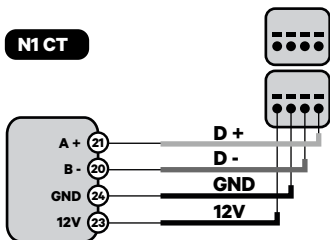

SPM1-100-AC

Only Power Boost

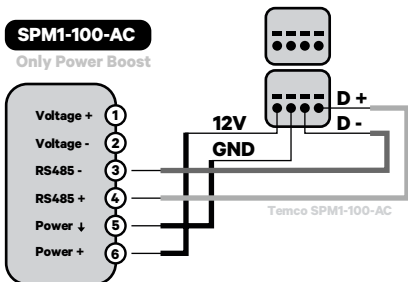

Pro MOD2

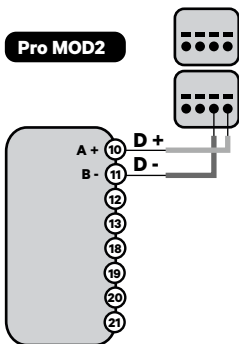

Pro 380 MOD

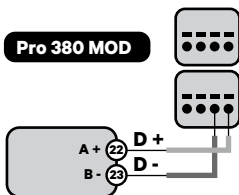

Commander 2

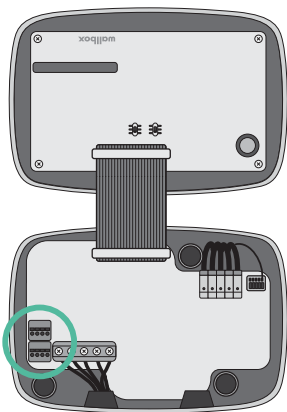

EM 112

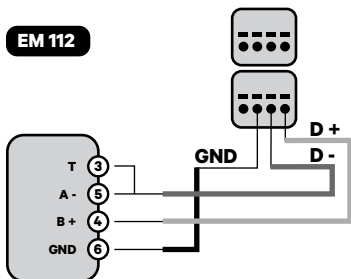

EM 340

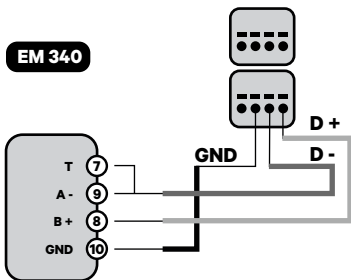

EM 330

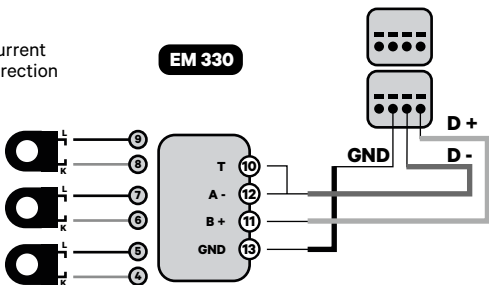

N1 CT

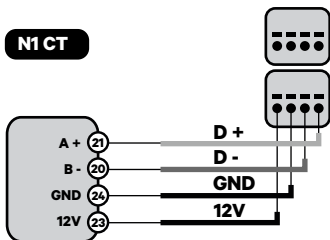

SPM1-100-AC

Only Power Boost

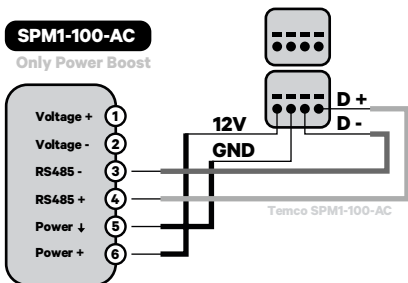

Pro MOD2

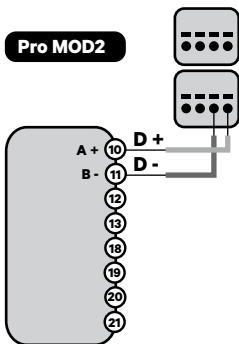

Pro 380 MOD

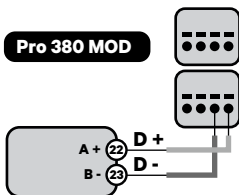

Copper SB

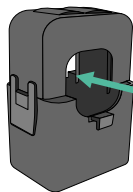
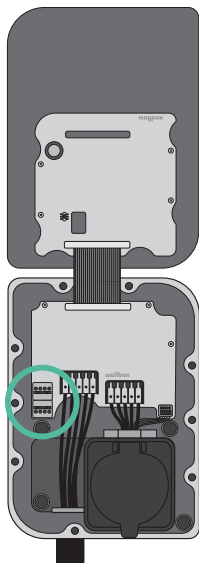

Current
Direction

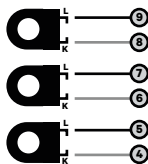

EM 112

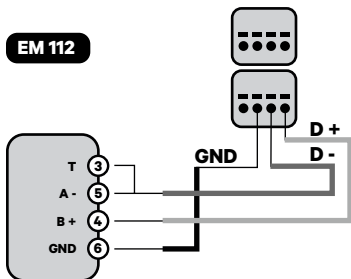

EM 340

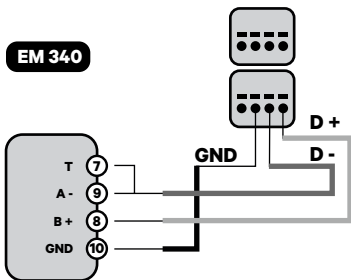

EM 330

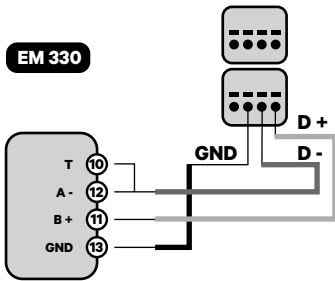

N1 CT

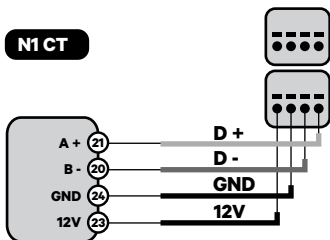

SPM1-100-AC

Only Power Boost

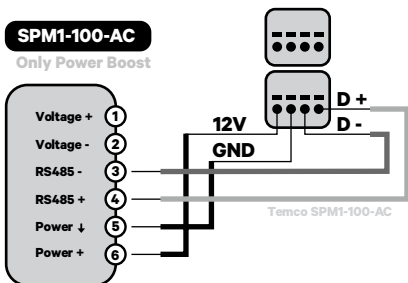

Pro MOD2

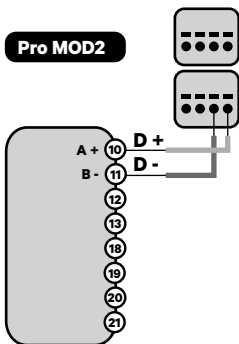

Pro 380 MOD

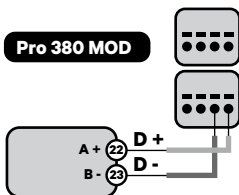

Configuration

Power Boost

Follow these steps to configure the **Power Boost** functionality.

Eco-Smart

Follow these steps to configure the **Eco-Smart** functionality.



support.wallbox.com